



# MENU HOLDERS

- FR** PROTÈGE-MENUS
- DE** SPEISEKARTEN
- IT** PORTA MENÙ
- ES** PORTA MENÚS
- PT** SUPORTES PARA MENU
- NL** MENUKAARTEN

# LEATHER RANGE

100% repurposed natural eco-leather, 0% production waste, easy to clean A5 and A4 menu covers, as well as modern placemats. Menu cards include a printed metal plate. Menu cards include a printed metal plate. Additional metal plate\* included for personalized printing or engraving.

**FR** Protèges-menu A5 et A4, et sets de table modernes, en cuir écologique à 100% recyclé, 0% de production de déchets, faciles à nettoyer. Les protège-menus comprennent une plaque métallique imprimée « MENU ».

Plaque métallique supplémentaire\* incluse, que vous pouvez graver ou imprimer pour personnaliser le menu.

**DE** Speisekarten aus 100% recyceltem, natürlich gebundenem Leder, 0% Produktionsabfälle. Einfach zu reinigende Speisekarten in A4 und A5 Format und moderne Tischsets. Speisekarten mit Edelstahlplatte mit "Menu" bedruckt. Inklusive einer zusätzlichen Edelstahlplatte\*, die nach eigenem Wunsch bedruckt/graviert werden kann.

**IT** Porta menù e tovagliette da tavolo moderne in ecopelle naturale 100% riciclata, 0% scarto di produzione, disponibili nel formato A4 e A5, facile da pulire. Placca in metallo con la scritta MENU inclusa. In aggiunta un'ulteriore placca in metallo personalizzabile.

**ES** Porta menù en formatos A4 y A5, y modernos manteles individuales, 100% de cuero natural reciclado, 0% de desperdicio de producción, fácil de limpiar. El porta menù incluye una placa metálica impresa y una placa metálica sin impresión para personalizar con su propio logo o nombre.

**PT** Suporte para menu nos formatos A4 e A5, e modernos jogos americanos, 100% couro ecológico, 0% de resíduos de produção, fácil de limpar. O suporte para menu inclui uma placa de metal impressa e uma placa de metal personalizável.

**NL** 100% natuurlijk ecologisch leer, 0% productieafval, eenvoudig te reinigen A5 en A4 menukaarten, en moderne placemats. Gedrukte metalen plaat op de menukaarten. Extra metalen plaat \* inbegrepen voor gepersonaliseerde bedrukking of graveren.



1 x 10  
**1 MC-LRPM-RUBR** 32,4x45x0,3cm 0,3kg

1 x 10  
**2 MC-LRAS-RUBR** 25x17,5x0,5cm 0,2kg  
**3 MC-LRA4-RUBR** 33,2x24,6x0,5cm 0,3kg

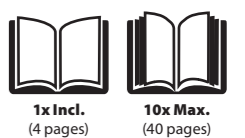
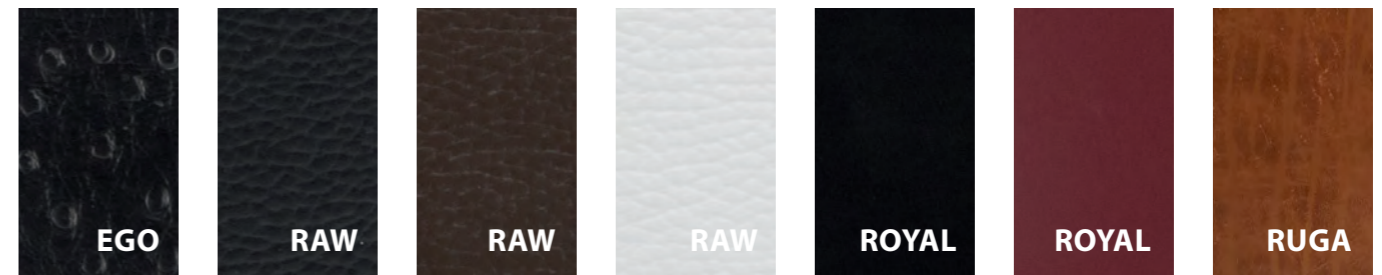

x SKU/item x Inner x Master



A4 1

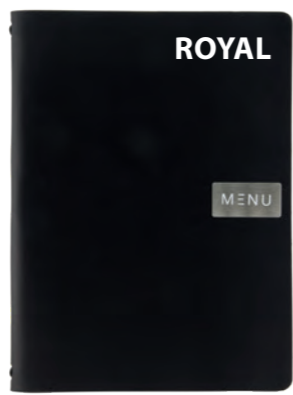

A4 2



A4 3



A4 5



A4 6

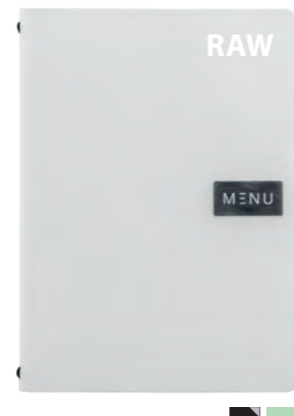

A4 7



A4 9



10



12

11

A5  
1 x 10  
25x17,5x0,5cm 0,2kg  
4 MC-LRA5-RWBL  
8 MC-LRA5-RUBR

A4  
1 x 10  
33,2x24,6x0,5cm 0,3kg  
1 MC-LRA4-EGBL  
2 MC-LRA4-ROBL  
3 MC-LRA4-RORD  
5 MC-LRA4-RWBL  
6 MC-LRA4-RWBR  
7 MC-LRA4-RWWT  
9 MC-LRA4-RUBR

1 10 40  
18,4x10,4x2cm 0,1kg  
10 MC-DBBP-GY

1 x 10  
32,4x45x0,3cm 0,3kg  
11 MC-LRPM-RWBL  
12 MC-LRPM-RUBR



# CLASSIC RANGE

Polyurethane menu cover embossed with "Menu", elastic inner cord to hold inserts, stitched edges and metal corner protectors. Easy to clean. Available in three colours.

*Menu*

**FR** Protège-menu en polyuréthane avec l'inscription "Menu" sur la couverture, en lettres dorées. Un élastique pour l'insertion et le maintien des inserts, bords cousus et coins de protections en métal. Facile à nettoyer. Disponible en 3 coloris.

**DE** Klassische Polyurethan Speisekarte auf dem Umschlag in Gold mit "Menu" bedruckt, mit metallenen Schutzecken und handgestickten Seitenrändern. Einfach zu reinigen. Mit elastischem Band für das Befestigen der Einlagen. Erhältlich in 3 verschiedenen Farben.

**IT** Porta menù in similpelle. Scritta "Menu" in oro stampata sulla copertina. Elastico all'interno per contenere gli inserti, angoli protettivi in metallo e bordi rifiniti, facile da pulire. Disponibile in tre colori.

**ES** Porta menú de simil cuero PU, con la palabra "Menu" impresa en dorado sobre la cubierta. Cordón elástico en su interior para sujetar las fundas. Con protectores de esquinas de metal y bordes cosidos. Fácil de limpiar. Disponible en tres colores.

**PT** Suporte para menu com efeito pele PU, com inscrição "Menu" a dourado. Elástico no interior para segurar a inserções, protetores de canto em metal e bordas costuradas. Disponível em 3 cores.

**NL** Menukaart van polyurethaan met "Menu" in goud bedrukt op de omslag, elastisch binnenkoord om insteekhoezen vast te houden, metalen hoekbeschermers en gestikte randen. Eenvoudig te reinigen. Verkrijgbaar in drie kleuren.



- 1 10 40  
34,4x24,5x0,5cm 0,3kg  
1 MC-CRA4-BL  
2 MC-CRA4-BR  
3 MC-CRA4-WR
- 4  
34,4x24,5x0,5cm 0,3kg  
4 MC-CRWC-BL
- 5 10 40  
35x18,4x1cm 0,2kg  
5 MC-CR45-BL  
6 MC-CR45-WR
- 7 10 40  
25x18x0,5cm 0,1kg  
7 MC-CRA5-BL  
8 MC-CRA5-BR  
9 MC-CRA5-WR



10 10 40  
23,9x13,1x0,5cm 0,1kg  
10 MC-CRBP-BL



**20x A4**  
1 1 x  
35x28x19,8cm 7kg  
11 MC-BOX-CRA4-WR  
12 MC-BOX-CRA4-BR  
13 MC-BOX-CRA4-BL

MENU HOLDERS

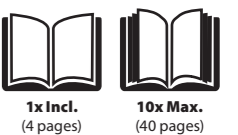



## TRENDY RANGE

PU menu cover embossed with "Menu," elastic inner cord to hold inserts, stitched edges and easy to clean. Available in five colours.

**FR** Protège-menu en polyuréthane avec l'inscription "Menu" en relief sur la couverture. Un élastique pour l'insertion et le maintien des inserts, bords cousus, faciles à nettoyer. Disponible en 5 coloris.

**DE** Polyurethan Speisekarte mit Text "Menu" auf dem Umschlag mit handgestickten Seitenrändern. Einfach zu reinigen. Mit elastischem Band für das Befestigen der Einlagen. Erhältlich in 5 verschiedenen Farben.

**IT** Porta menù in similpelle. Scritta "Menu" stampata in bassorilievo sulla copertina. Elastico all'interno per contenere gli inserti e bordi rifiniti. Facile da pulire. Disponibile in cinque colori.

**ES** Porta menú de simil cuero PU, con la palabra "Menu" impresa en la cubierta. Bordes cosidos y cordón elástico en su interior para sujetar las fundas. Fácil de limpiar. Disponible en cinco colores.

**PT** Suporte para menu com efeito pele, com texto "Menu" em baixo-relevo na capa. Elástico no interior para segurar as inserções e bordas cosidas. Fácil de limpar. Disponível em cinco cores.

**NL** PU-materiaal, "Menu" in reliëf op de omslag, elastisch binnenkoord om insteekhoezen vast te houden, gestikte randen en eenvoudig te reinigen. Verkrijgbaar in vijf kleuren.

# MENU

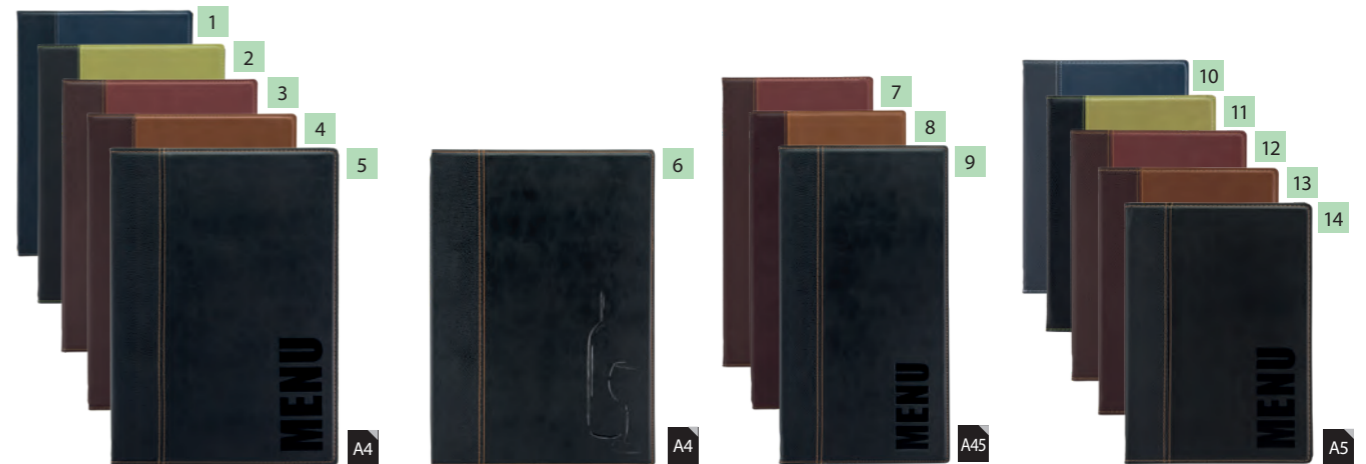

- 1 10 40  
34x24,6x0,4cm 0,3kg
- 1 MC-TRA4-BU
  - 2 MC-TRA4-GR
  - 3 MC-TRA4-WR
  - 4 MC-TRA4-LB
  - 5 MC-TRA4-BL

- 1 10 40  
34x24,6x0,4cm 0,3kg
- 6 MC-TRWC-BL

- 1 10 40  
35,3x18,6x1cm 0,3kg
- 7 MC-TR45-WR
  - 8 MC-TR45-LB
  - 9 MC-TR45-BL

- 1 10 40  
25,3x17,7x0,8cm 0,2kg
- 10 MC-TRA5-BU
  - 11 MC-TRA5-GR
  - 12 MC-TRA5-WR
  - 13 MC-TRA5-LB
  - 14 MC-TRA5-BL



- 1 x x  
35,2x27,9x19,7cm 8,2kg
- 18 MC-BOX-TRA4-BL
  - 19 MC-BOX-TRA4-LB
  - 20 MC-BOX-TRA4-WR
  - 21 MC-BOX-TRA4-GR
  - 22 MC-BOX-TRA4-BU

- 1 10 40
- 15 MC-TRBP-BL 23,4x12,8x0,5cm 0,1kg
  - 16 MC-DBBP-BL 18,4x10,4x2cm 0,1kg
  - 17 MC-BPBOX-TR 18,3x12,5x4cm 0,2kg

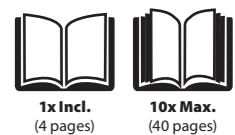
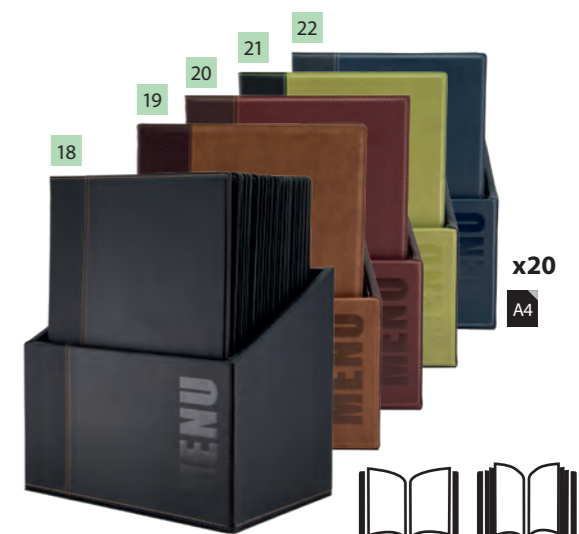

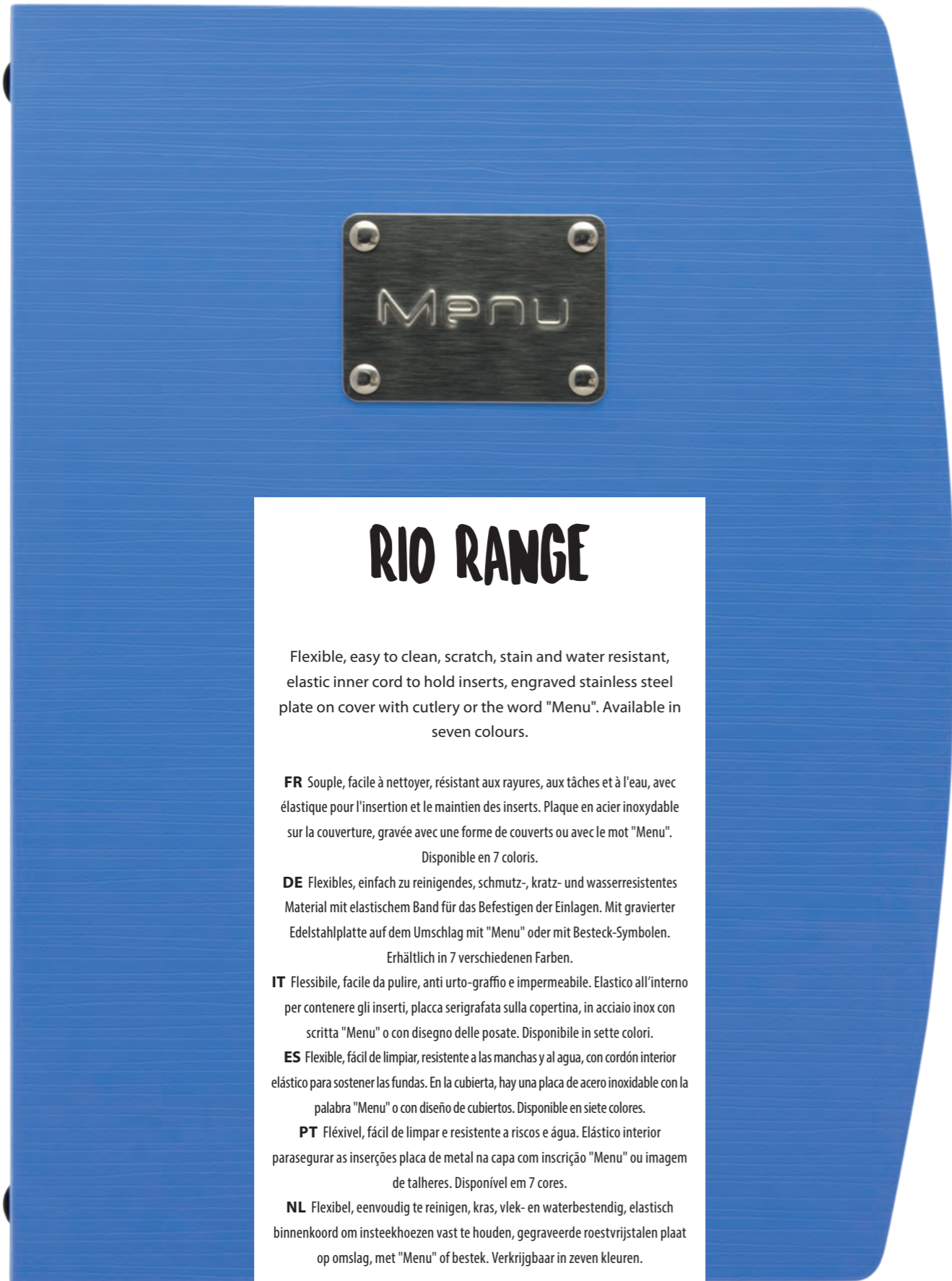

# RIO RANGE

Flexible, easy to clean, scratch, stain and water resistant, elastic inner cord to hold inserts, engraved stainless steel plate on cover with cutlery or the word "Menu". Available in seven colours.

**FR** Souple, facile à nettoyer, résistant aux rayures, aux tâches et à l'eau, avec élastique pour l'insertion et le maintien des inserts. Plaque en acier inoxydable sur la couverture, gravée avec une forme de couverts ou avec le mot "Menu". Disponible en 7 coloris.

**DE** Flexibles, einfach zu reinigendes, schmutz-, kratz- und wasserresistentes Material mit elastischem Band für das Befestigen der Einlagen. Mit gravierter Edelstahlplatte auf dem Umschlag mit "Menu" oder mit Besteck-Symbolen. Erhältlich in 7 verschiedenen Farben.





**IT** Flessibile, facile da pulire, anti urto-graffio e impermeabile. Elastico all'interno per contenere gli inserti, placca serigrafata sulla copertina, in acciaio inox con scritta "Menu" o con disegno delle posate. Disponibile in sette colori.

**ES** Flexible, fácil de limpiar, resistente a las manchas y al agua, con cordón interior elástico para sostener las fundas. En la cubierta, hay una placa de acero inoxidable con la palabra "Menu" o con diseño de cubiertos. Disponible en siete colores.

**PT** Fléxivel, fácil de limpar e resistente a riscos e água. Elástico interior para segurar as inserções placa de metal na capa com inscrição "Menu" ou imagem de talheres. Disponível em 7 cores.

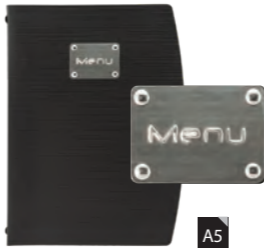
**NL** Flexibel, eenvoudig te reinigen, kras, vlek- en waterbestendig, elastisch binnenkoord om insteekhoezen vast te houden, gegraveerde roestvrijstalen plaat op omslag, met "Menu" of bestek. Verkrijgbaar in zeven kleuren.



<p><b>1</b></p>  <p>A5</p> <p><b>1 10 40</b></p> <p>23,5x18x1,1cm 0,1kg</p> <p><b>1 MC-RCA5-BL</b></p>	<p><b>2 3 4 5 6 7 8</b></p>  <p>A4</p> <p><b>1 10 40</b></p> <p>34x25,5x1,8cm 0,2kg</p> <p><b>2 MC-RCA4-VT</b>  <b>3 MC-RCA4-RD</b>  <b>4 MC-RCA4-OR</b>  <b>5 MC-RCA4-GR</b>  <b>6 MC-RCA4-BU</b>  <b>7 MC-RCA4-BL</b>  <b>8 MC-RCA4-WT</b></p>	<p><b>1 10 40</b></p> <p>34x25,5x1,8cm 0,2kg</p> <p><b>10 MC-RCA4-VT-FK</b>  <b>11 MC-RCA4-RD-FK</b>  <b>12 MC-RCA4-OR-FK</b>  <b>13 MC-RCA4-GR-FK</b>  <b>14 MC-RCA4-BU-FK</b>  <b>15 MC-RCA4-BL-FK</b>  <b>16 MC-RCA4-WT-FK</b></p>
<p><b>9</b></p>  <p>A4</p> <p><b>1 10 40</b></p> <p>34x25,5x1,8cm 0,2kg</p> <p><b>9 MC-RCWC-BL</b></p>	<p><b>10 11 12 13 14 15 16</b></p>  <p>A4</p>	

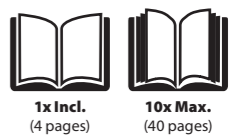



# NATURE RANGE

Natural fibre menu cover with an elastic band inside to hold inserts. One double-sided insert included. Available in three different colours in A4 and A5 size.

**FR** Protège-menu en fibre naturelle, avec élastique pour l'insertion et le maintien des inserts. Un double-insert inclus. Disponible en 3 différents coloris, aux formats A4 et A5.

**DE** Speisekarte aus Naturfaser mit einem elastischem Band für das Befestigen von Einlagen. Inklusive einer doppelseitigen Einlage. In 3 verschiedenen Farben und in A4 und A5 Format erhältlich.

**IT** Porta menù in fibra naturale 100% impermeabile. Elastico interno per contenere gli inserti A4 e con un inserto a doppia faccia incluso. Disponibile in A4 e A5 in tre colori differenti.

**ES** Porta menù a prueba de agua, 100% de fibra natural. Incluye una funda doble y un elástico interno para colocar más fundas. Disponible en formatos A4 y A5 y en 3 colores.

**PT** Suporte para menu a prova d'água, 100% fibra natural. Inclui uma inserção dupla A4 e um elástico interno para colocar mais inserções. Disponível nos formatos A4 e A5 e em 3 cores.

**NL** Menukaart van natuurvezel met een elastische band aan de binnenkant voor A4- insteekhoezen. Dubbelzijdige A4-insteekhoes inbegrepen. Beschikbaar in 3 verschillende kleuren in A4 en A5 formaat.



A4

- 1 x 10
- 34x24,5x1cm 0,2kg
- 1 MC-NTA4-BI
- 2 MC-NTA4-BR
- 3 MC-NTA4-BL



A5

- 1 10 40
- 24,9x17,5x1cm 0,1kg
- 4 MC-NTA5-BI
- 5 MC-NTA5-BR
- 6 MC-NTA5-BL

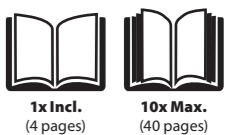

# DESIGN RANGE

Polyurethane menu cover with hand stitched edges and elastic inner cord to hold inserts. Easy to clean. Available in six styles and designs with embedded or engraved text on cover.

**FR** Protège-menu en polyuréthane avec bords cousus à la main, avec élastique pour l'insertion et le maintien des inserts. Facile à nettoyer. Disponible en 6 modèles et coloris avec texte gaufré, ou gravé, sur la couverture.

**DE** Polyurethan Speisekarten mit handgestickten Seitenrändern und elastischem Band für das Befestigen der Einlagen. Einfach zu reinigen. Erhältlich in diversen Modellen und Designs mit geprägten oder eingebetteten Texten auf dem Speisekarteneinband.

**IT** Porta menù realizzato in similpelle, facile da pulire, elastico all'interno per contenere gli inserti, bordi rifiniti. Disponibile in 6 stili e designs con testo in rilievo o bassorilievo sulla copertina.

**ES** Porta menú de simil cuero PU, fácil de limpiar, con cordón interior elástico para sostener las fundas y bordes cosidos. Disponible en 6 estilos y diseños con el texto en relieve o incrustado en la cubierta.

**PT** Suporte para menu com efeito pele, fácil de limpar. Com elástico interior que permite suportar as micas e bordas costuradas. Disponível em 6 estilos diferentes, com texto embutido na capa.

**NL** Menukaart van polyurethaan met handgestikte randen en elastisch binnenkoord om insteekhoezen vast te houden. Gemakkelijk schoon te maken. Beschikbaar in 6 stijlen en ontwerpen met ingebedde of gegraveerde tekst op de omslag.



1	10	40		
1	MC-TRBC-WT	35,2x18,5x0,8cm	0,3kg	
2	MC-DR45-CROC	35x19x1,5cm	0,4kg	
1	x	2		
9	MC-BOX-DRA4-CORK	35,2x27x14,6cm	5,6kg	
10	MC-BOX-DRA4-PAISLEY	35,2x27x14,6cm	5,6kg	
11	MC-BOX-DRWC-CORK	35,2x27x14,6cm	4,9kg	

1	10	40		
3	MC-DRA4-WOOD	34,4x25x0,7cm	0,4kg	
4	MC-DRA4-VELVET	34,4x25x0,7cm	0,4kg	
5	MC-DRWC-VELVET	34,4x25x0,7cm	0,4kg	
6	MC-DRA4-CORK	34,4x25x0,7cm	0,4kg	
7	MC-DRA4-PAISLEY	34,4x25x0,7cm	0,4kg	
8	MC-DRWC-CORK	34,4x25x0,7cm	0,4kg	

MENU HOLDERS

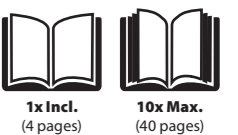



# MENU HOLDER INSERTS

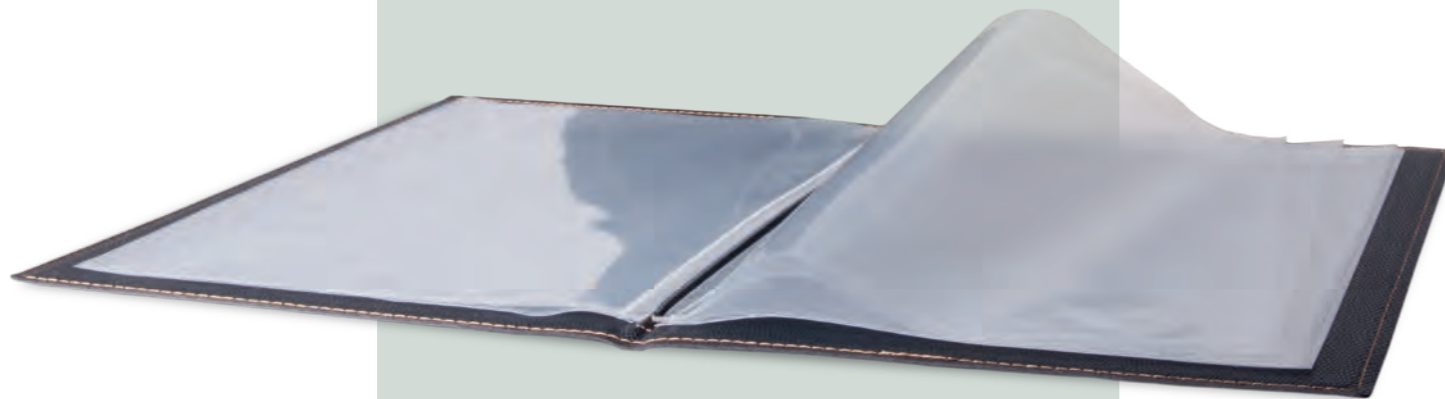

INSERTS POUR PROTEGE-MENUS  
 EINLAGEN FÜR SPEISEKARTEN  
 INSERTI PER PORTA MENÙ  
 FUNDAS PARA PORTA MENÚ  
 INSERÇÕES PARA PORTA MENUS  
 MENUKAART INSTEELKHOEZEN

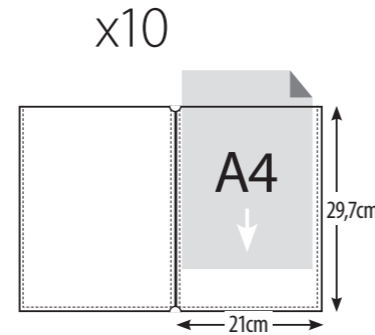

  
**MC-TIA4** 45x30x0,1cm 0,2kg

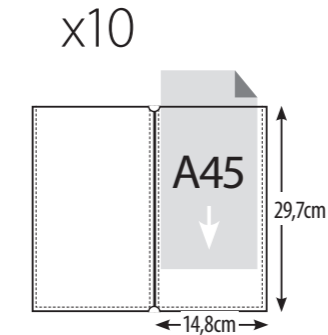

  
**MC-TIA5** 33x30,5x0,4cm 0,2kg

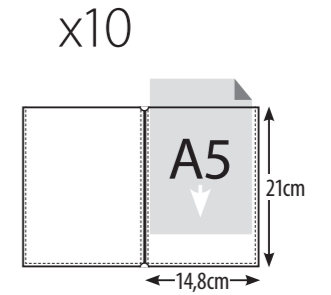

  
**MC-TIA5** 22x32,8x0,4cm 0,1kg

- |   |  |
|---|--|
| <p><b>LEATHER RANGE</b></p> <ul style="list-style-type: none"> <li>MC-LRA4-EGBL</li> <li>MC-LRA4-ROBL</li> <li>MC-LRA4-RORD</li> <li>MC-LRA4-RUBR</li> <li>MC-LRA4-RWBL</li> <li>MC-LRA4-RWBR</li> <li>MC-LRA4-RWWT</li> </ul> <p><b>CLASSIC RANGE</b></p> <ul style="list-style-type: none"> <li>MC-CRA4-BL</li> <li>MC-CRA4-BR</li> <li>MC-CRA4-WR</li> <li>MC-CRWC-BL</li> </ul> <p><b>TRENDY RANGE</b></p> <ul style="list-style-type: none"> <li>MC-TRA4-BL</li> <li>MC-TRA4-BU</li> <li>MC-TRA4-GR</li> <li>MC-TRA4-LB</li> <li>MC-TRA4-WR</li> <li>MC-TRWC-BL</li> </ul> <p><b>NATURE RANGE</b></p> <ul style="list-style-type: none"> <li>MC-NTA4-BI</li> <li>MC-NTA4-BL</li> <li>MC-NTA4-BR</li> </ul> | <p><b>RIO RANGE</b></p> <ul style="list-style-type: none"> <li>MC-RCA4-BL</li> <li>MC-RCA4-BL-FK</li> <li>MC-RCA4-BU</li> <li>MC-RCA4-BU-FK</li> <li>MC-RCA4-GR</li> <li>MC-RCA4-GR-FK</li> <li>MC-RCA4-OR</li> <li>MC-RCA4-OR-FK</li> <li>MC-RCA4-RD</li> <li>MC-RCA4-RD-FK</li> <li>MC-RCA4-VT</li> <li>MC-RCA4-VT-FK</li> <li>MC-RCA4-WT</li> <li>MC-RCA4-WT-FK</li> <li>MC-RCWC-BL</li> </ul> <p><b>DESIGN RANGE</b></p> <ul style="list-style-type: none"> <li>MC-DRA4-CORK</li> <li>MC-DRA4-PAISLEY</li> <li>MC-DRA4-VELVET</li> <li>MC-DRA4-WOOD</li> <li>MC-DRWC-CORK</li> <li>MC-DRWC-VELVET</li> </ul> |
|---|--|

  
**1x Incl.** (4 pages) **10x Max.** (40 pages)

- CLASSIC RANGE**
- MC-CR45-BL
  - MC-CR45-WR
- TRENDY RANGE**
- MC-TR45-BL
  - MC-TR45-LB
  - MC-TR45-WR
- DESIGN RANGE**
- MC-DR45-CROC
  - MC-TRBC-WT

  
**1x Incl.** (4 pages) **10x Max.** (40 pages)

- LEATHER RANGE**
- MC-LRA5-RUBR
  - MC-LRA5-RWBL
- CLASSIC RANGE**
- MC-CRA5-BL
  - MC-CRA5-BR
  - MC-CRA5-WR
- TRENDY RANGE**
- MC-TRA5-BL
  - MC-TRA5-BU
  - MC-TRA5-GR
  - MC-TRA5-LB
  - MC-TRA5-WR
- RIO RANGE**
- MC-RCA5-BL
- NATURE RANGE**
- MC-NTA5-BI
  - MC-NTA5-BL
  - MC-NTA5-BR

  
**1x Incl.** (4 pages) **10x Max.** (40 pages)

# WOOD RANGE

Teak wooden spine, stitched edges, golden metal corners, anti-reflective frosted windows, and golden screws to add or remove inserts. Available in different colours.

**FR** Dos en teck, bords cousus, coins de protection en métal doré, fenêtre dépolie anti-reflets et vis dorées permettant l'insertion ou le retrait des inserts. Disponible en divers coloris.

**DE** Speisekarte mit Teakholzschiene, handgesticktem Rand, goldfarbenen Metallecken und anti-reflektierender, matter Oberfläche. Goldfarbene Schrauben um weitere Einlagen hinzuzufügen oder auszutauschen. Erhältlich in verschiedenen Farben.

**IT** Porta menù con struttura laterale in legno teck, bordi rifiniti, angoli protettivi in metallo dorato e inserti antiriflesso con effetto satinato, viti dorate per l'inserimento/rimozione degli inserti. Disponibile in sei colori.

**ES** Porta menù con lomo de teka, bordes cosidos, protectores metálicos en las esquinas de color dorado. Cubierta antirreflejo. Tornillos dorados para la inserción o extracción de los fundas. Disponible en seis colores.

**PT** Suporte para menu em madeira de teka, bordas costuradas e com inserções foscas e proteções de canto douradas. Parafusos dourados que permitem adicionar ou remover inserções. Disponível em 6 cores.

**NL** Teak houten rug, gestikte randen, goudkleurige metalen beschermhoeken, anti-reflecterend matte pagina's en gouden schroeven om insteekhoezen toe te voegen of te verwijderen. Verkrijgbaar in verschillende kleuren.

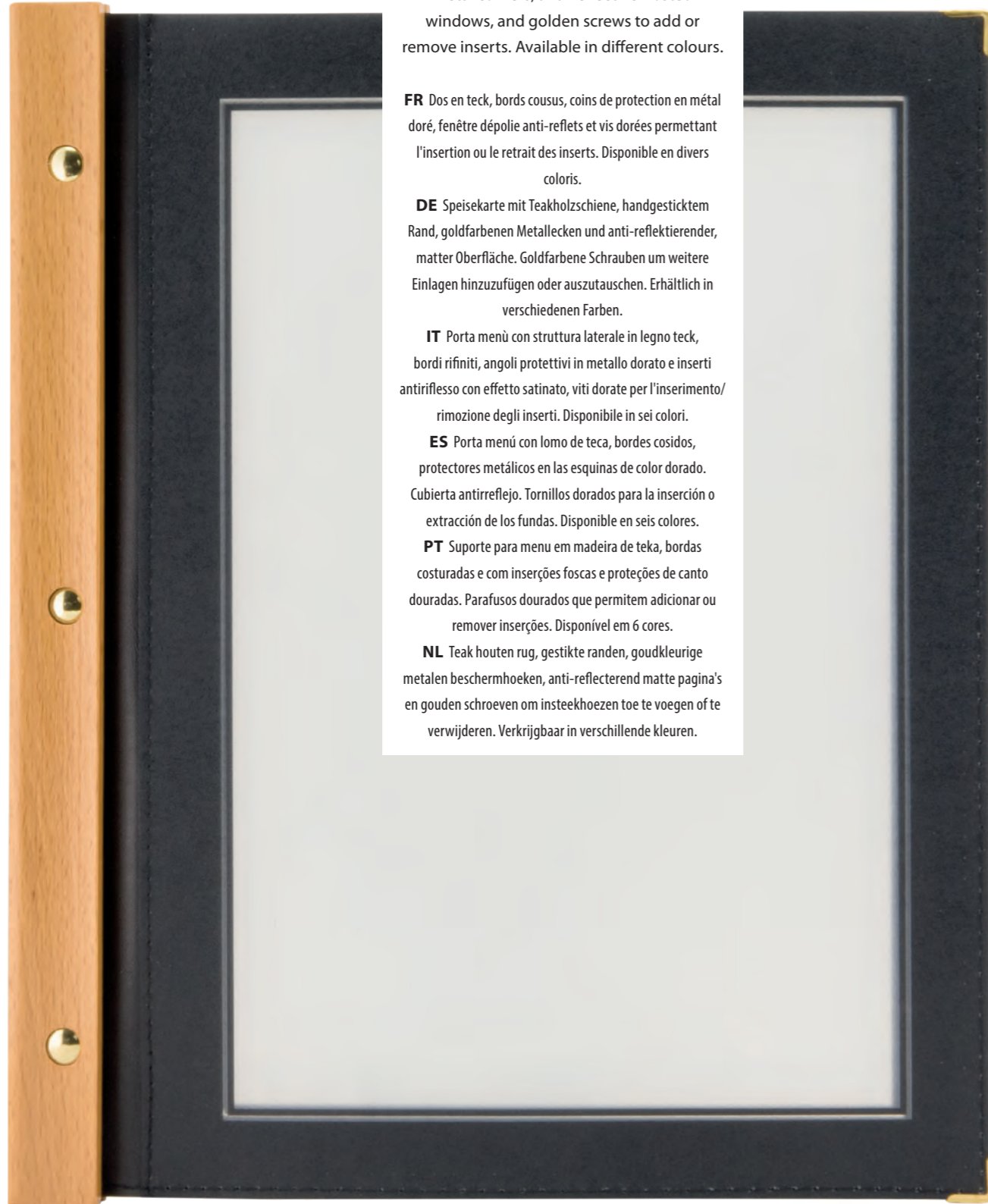

1 10 40  
32,2x26,6x2cm 0,24kg  
1 MC-WRA4-BL  
2 MC-WRA4-BR  
3 MC-WRA4-WR  
4 MC-WRA4-BU

1 10 40  
32,2x26x0,1cm 0,1kg  
5 MC-WIA4-BL  
6 MC-WIA4-BR  
7 MC-WIA4-WR  
8 MC-WIA4-BU



1 10 40  
24x20,5x2cm 0,1kg  
9 MC-WRA5-BL  
10 MC-WRA5-BR  
11 MC-WRA5-WR  
12 MC-WRA5-BU

1 10 40  
23,5x19,8x0,1cm 0,04kg  
13 MC-WIA5-BL  
14 MC-WIA5-BR  
15 MC-WIA5-WR  
16 MC-WIA5-BU



1 x x  
33,7x30,1x24,6cm 6,4kg  
17 MC-BOX-WRA4-WR  
18 MC-BOX-WRA4-BR  
19 MC-BOX-WRA4-BL

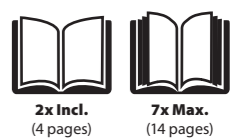

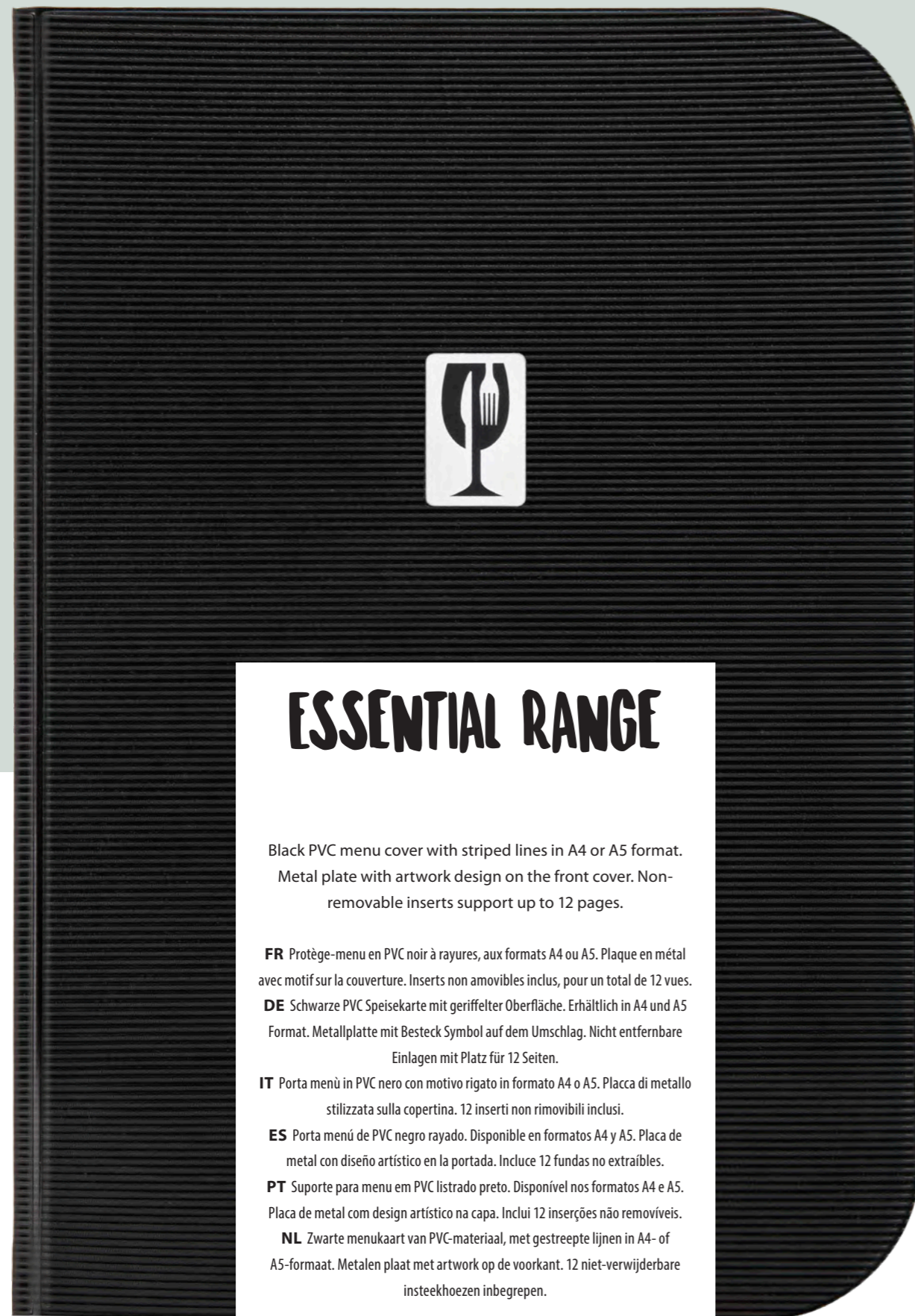

## ESSENTIAL RANGE

Black PVC menu cover with striped lines in A4 or A5 format.  
Metal plate with artwork design on the front cover. Non-removable inserts support up to 12 pages.

**FR** Protège-menu en PVC noir à rayures, aux formats A4 ou A5. Plaque en métal avec motif sur la couverture. Inserts non amovibles inclus, pour un total de 12 vues.

**DE** Schwarze PVC Speisekarte mit geriffelter Oberfläche. Erhältlich in A4 und A5 Format. Metallplatte mit Besteck Symbol auf dem Umschlag. Nicht entfernbare Einlagen mit Platz für 12 Seiten.

**IT** Porta menù in PVC nero con motivo rigato in formato A4 o A5. Placca di metallo stilizzata sulla copertina. 12 inserti non rimovibili inclusi.

**ES** Porta menù de PVC negro rayado. Disponible en formatos A4 y A5. Placa de metal con diseño artístico en la portada. Incluye 12 fundas no extraíbles.

**PT** Suporte para menu em PVC listrado preto. Disponível nos formatos A4 e A5. Placa de metal com design artístico na capa. Inclui 12 inserções não removíveis.

**NL** Zwarte menukaart van PVC-materiaal, met gestreepte lijnen in A4- of A5-formaat. Metalen plaat met artwork op de voorkant. 12 niet-verwijderbare insteekhoezen inbegrepen.



1  
A4



2  
A5



1 10 40

1 MC-ESA4-BL 31,5x24x1cm 0,4kg

2 MC-ESA5-BL 26x17,2x1cm 0,2kg

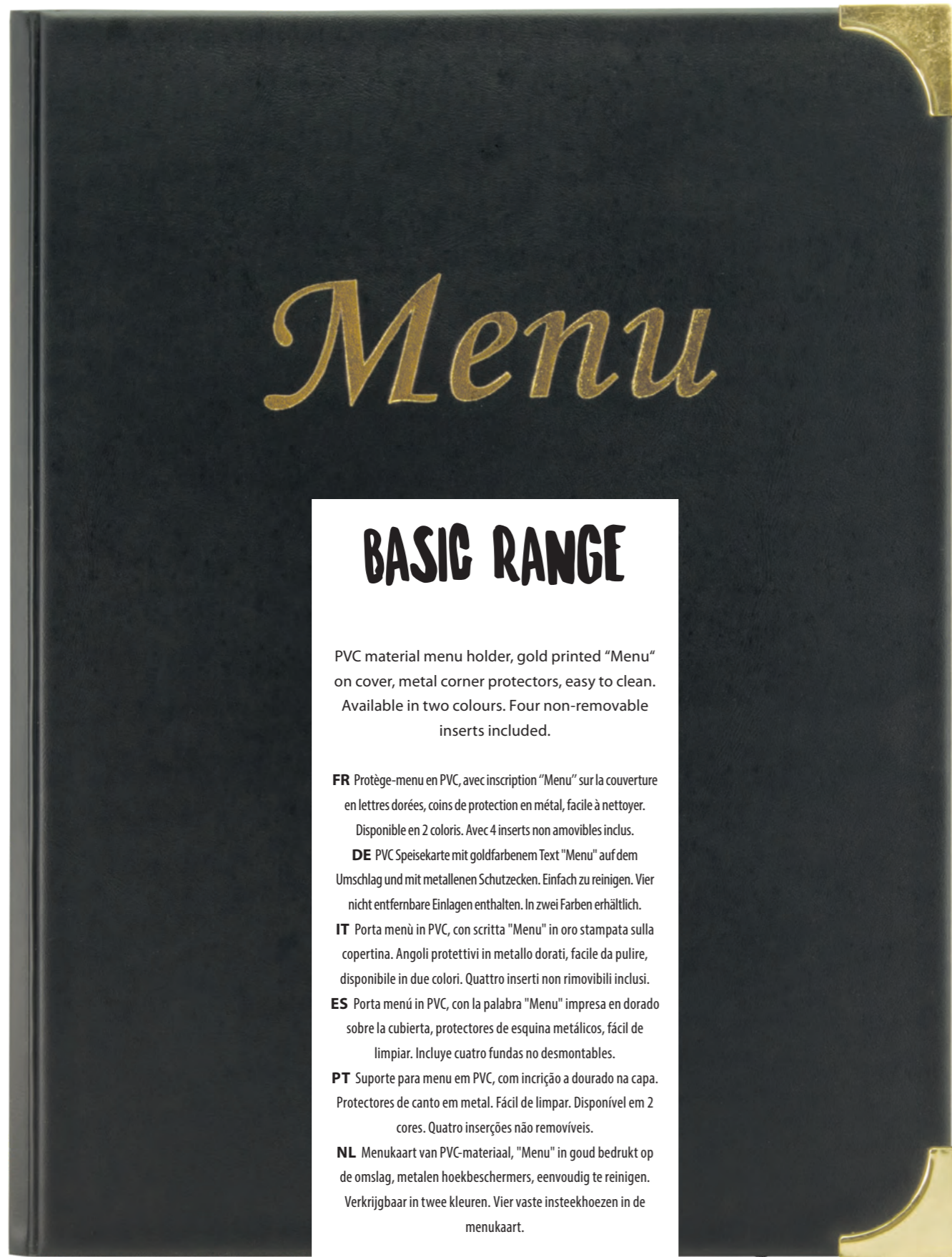

## BASIC RANGE

PVC material menu holder, gold printed "Menu" on cover, metal corner protectors, easy to clean. Available in two colours. Four non-removable inserts included.

**FR** Protège-menu en PVC, avec inscription "Menu" sur la couverture en lettres dorées, coins de protection en métal, facile à nettoyer. Disponible en 2 coloris. Avec 4 inserts non amovibles inclus.

**DE** PVC Speisekarte mit goldfarbenem Text "Menu" auf dem Umschlag und mit metallenen Schutzecken. Einfach zu reinigen. Vier nicht entfernbar Einlagen enthalten. In zwei Farben erhältlich.

**IT** Porta menù in PVC, con scritta "Menu" in oro stampata sulla copertina. Angoli protettivi in metallo dorati, facile da pulire, disponibile in due colori. Quattro inserti non rimovibili inclusi.

**ES** Porta menú in PVC, con la palabra "Menu" impresa en dorado sobre la cubierta, protectores de esquina metálicos, fácil de limpiar. Incluye cuatro fundas no desmontables.

**PT** Suporte para menu em PVC, com inscrição a dourado na capa. Protectores de canto em metal. Fácil de limpar. Disponível em 2 cores. Quatro inserções não removíveis.

**NL** Menukaart van PVC-materiaal, "Menu" in goud bedrukt op de omslag, metalen hoekbeschermers, eenvoudig te reinigen. Verkrijgbaar in twee kleuren. Vier vaste insteekhoezen in de menukaart.



1 10 40  
31,5x24x1cm 0,4kg  
1 MC-BRA4-BL  
2 MC-BRA4-WR



3 10 40  
23,7x17,2x0,8cm 0,2kg  
3 MC-BRAS-BL  
4 MC-BRAS-WR



5 10 40  
31,5x24x1cm 0,4kg  
5 MC-BRWC-BL



6 10 40  
32,2x26x0,1cm 0,1kg  
6 MC-BRBP-BL



7 x x  
30,5x27x20cm 5,1kg  
7 MC-BOX-BRA4-BL  
8 MC-BOX-BRA4-WR

# WALNUT RANGE

Menu holders handmade from lacquered walnut wood, with precision-cut smooth edges.

**FR** Protège-menu fait main en bois de noyer laqué. Avec des bords lisses, découpés avec précision.

**DE** Handgefertigte Speisekarten aus lackiertem Walnussholz mit präzise geformten, abgerundeten Ecken.

**IT** Porta menù realizzati a mano in legno di noce laccato con angoli e lati perfettamente rifiniti.

**ES** Porta menù hecho a mano de madera de nogal lacada con bordes y esquinas perfectamente acabados.

**PT** Porta menus fabricados à mão em madeira de nogueira, lacado com extremidades lisas e bem acabadas.

**NL** Handgemaakte menu houders van walnotenhou, gelakt, met precisiegeslepen gladde randen.

## Album



A4

Board surface covered in soft PU material, easy to clean, with corner pockets to hold menu sheets.

**FR** Panneau couvert d'une surface en polyuréthane doux, facile à nettoyer, avec des coins pouvant accueillir les feuilles de menu.

**DE** Walnuss Speisekarte im Album Stil mit weichem PU-Material als Untergrund, einfach zu reinigen, mit Ecktaschen für eine A4 Seite.

**IT** Porta menù in legno di noce stile album, con un lato rivestito in morbida similpelle PU facile da pulire, con tasche angolari per contenere il menù.

**ES** Porta menù de madera de nogal estilo álbum. Un lado está recubierto de simil cuero suave y fácil de limpiar. Tiene bolsillos en las esquinas para sostener el menù.

**PT** Suporte para menu feito de madeira de nogueira estilo álbum, um dos lados é coberto com couro de imitação macio e fácil de limpar. Tem bolsos nos cantos para segurar o menu.

**NL** Board-oppervlak bedekt met zacht PU-materiaal, eenvoudig te reinigen, met hoekzakken om menubladen vast te houden.

1 10 40

MC-WALA4-PU 32x23,4x0,7cm 0,4kg



## Chopping Board



A4

1 10 40

MC-WALA4-CH 30x32,3x2,6cm 0,3kg

Two-ring binder, black, powder-coated metal.

**FR** Classeur 2 anneaux, noir, métallique thermolaqué.

**DE** Ringbuch Speisekarte mit 2 Ringen aus schwarzem, pulverbeschichtetem Metall.

**IT** Porta menù in legno stile tagliere con 2 anelli in metallo laccato nero.

**ES** Porta menù de madera de nogal estilo tabla de cortar, con 2 anillos de metal negro laqueado.

**PT** Suporte para menu estilo tábua de corta com duas anilhas em metal lacado a preto.

**NL** Ringband met twee ringen, zwart, gepoedercoat metaal.



## Tablet



A4

1 10 40

MC-WALA4-RB 32x22x0,8cm 0,3kg

Flexible, resistant bands to hold menu sheets.

**FR** Bandes résistantes, souples, pour le maintien des feuilles de menu.

**DE** Walnussholz Speisekarte mit zwei flexiblen, starken Gummibändern zum Befestigen des Menüs.

**IT** Porta menù in legno con 2 bande elastiche resistenti per sostenere i fogli.

**ES** Porta menù de manera de nogal, flexible, con bandas elásticas para sostener las páginas del menù.

**PT** Suporte para menu, flexível, com bandas elásticas para fixar as folhas menù.

**NL** Flexibele, elastische banden voor menubladen.



# WALNUT CLIP

Menu holders handmade from lacquered walnut wood. Black metal holding clip. Bill presenter in matching style.

**FR** Protège-menu fait main, en bois de noyer laqué. Pince en métal noir. Porte addition de la même gamme disponible.

**DE** Klemmbrett aus lackiertem Walnussholz mit schwarzer Metallklemme. Passende Rechnungsmappe erhältlich.

**IT** Porta menù realizzati a mano in legno di noce, laccato e con bordi lisci. Portaconto coordinato nello stesso stile.

**ES** Porta menù con clip hechos a mano de madera de nogal lacada y con bordes lisos y precisos. Porta cuentas a tono.

**PT** Suporte para menu om cliques feitos à mão em madeira de nogueira lacada com bordas lisas e precisas. Suporte de contas a condizer.

**NL** Handgemaakte menu houders van walnotenhou, gelakt, met precisiegeslepen gladde randen. Sterke veerklem van roestvrij staal. Rekeninghouder in bijpassende stijl.



A4

1

1 10 40

**1 MC-WALA4-CB**  
33x23x2,2cm 0,3kg

**2 MC-WALBP-BL**  
24x10x1,4cm 0,1kg

2

1



2



A4

1

A5

2

# WALNUT LEATHER

Walnut menu holder with vegan leather cover. Available in A4 and A5 format.

**FR** Protège-menu en noyer avec une couverture en cuir vegan. Disponible aux formats A4 et A5.

**DE** Walnuss Speisekarte mit Deckblatt aus Kunstleder. Erhältlich in den Formaten A4 und A5.

**IT** Porta menù in noce rivestito in pelle. Disponibile in A4 e A5.

**ES** Porta menù de madera de nogal con cubierta de cuero. Disponible en formatos A4 y A5.

**PT** Suporte para menu em madeira de nogueira com capa de couro. Disponivel nos formatos A4 e A5.

**NL** Walnoot-menuhouder met kunst lederen omslag. Beschikbaar in A4 en A5.

1 10 40

**1 MC-WALA4-SC2**  
33x23x1cm 0,3kg

**2 MC-WALA5-SC2**  
23x17x1cm 0,2kg





# VINTAGE CLIPBOARD

**NEW**

Warm grey HDF menu clipboard. Vintage metal patina clip with 'Food & Drink' artwork in an early 20th century style. Available in A4 and A5 format

**FR** Porte menu HDF (fibre de haute densité) de couleur gris perle. Clip rétro en métal patiné avec en relief l'inscription « Food & Drinks » dans un style début XXe siècle. Disponible en format A4 et A5.

**DE** Warm graues Menü Klemmbrett aus Hochdicht-Faser Holz. Vintage Patina Clip aus Edelstahl mit "Food & Drink" Design im Stil des frühen 20. Jahrhunderts. Erhältlich in den Formaten A4 und A5.

**IT** Portamenù clipboard HDF in grigio. Clip vintage in metallo con scritta "Food & Drink" in stile inizio XX secolo. Disponibile in formato A4 e A5.

**ES** Portamenú clipboard HDF de color gris. Clip de metal vintage con la escrita 'Food & Drink' en un estilo de principios del siglo XX. Disponible en formato A4 y A5.

**PT** Suporte de menu HDF em cor cinza. Clip vintage em metal com gravação "Food & Drink" estilo inicio seculo XX. Disponivel nos formatos A4 e A5.

**NL** Warmgrijs HDF klembord menuhouder. Metalen vintage klem met "Food & Drink" design in een vroege 20e eeuwse stijl. Beschikbaar in A4 en A5 formaat.

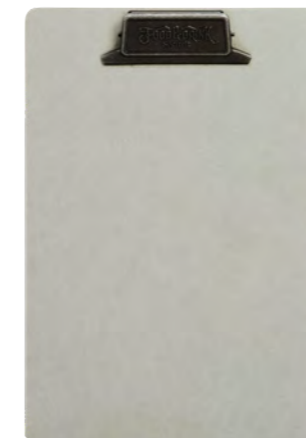

1 A4



2 A5



- 1 MC-CBA4-VT 33,5x23x3,5cm 0,4kg
- 2 MC-CBA5-VT 24,5x17x3,5cm 0,2kg

# METAL CLIPBOARD

Metal clipboard, easy to clean and easy to use. Includes an extra strong and modern metal clip to hold the menu.

**FR** Protège-menu en métal, facile à nettoyer et à utiliser. Comprend un clip métallique robuste et moderne, pour maintenir le menu.

**DE** Klemmbrett aus Metall, einfach zu reinigen und handhaben. Mit extra starker und moderner Metallklammer um das Menü zu befestigen.

**IT** Porta menù in metallo, facile da pulire e da usare. Include una clip in metallo molto resistente e moderna per fissare il menu.

**ES** Porta menú metálico fácil de limpiar y de usar. Incluye un clip de metal extra fuerte y moderno para sujetar el menú.

**PT** Suporte para menu em metal fácil de usar e de limpar. Inclui um clip de metal extra forte e moderno para colocar o menu.

**NL** Metalen klembord. Makkelijk te gebruiken en schoon te maken. Inclusief een extra sterke en moderne metalen clip om het menu vast te houden.



A4

1 10 40

MC-CBA4-MT 33,4x23x4cm 0,3kg

# CLIPBOARD

Hardboard, strong stainless-steel spring clip. Bill presenter in matching style.

**FR** Protège-menu avec pince robuste en acier inoxydable. Porte-addition de la même gamme disponible.

**DE** Hartfaserplatte-Klemmbrett mit starker Edelstahlklammer. Passende Rechnungsmappe erhältlich.

**IT** Porta menù in legno pressato con robusta clip in acciaio inox. Portaconto coordinato nello stesso stile.

**ES** Porta menú con acabo de madera prensada, clip fuerte con resorte del acero inoxidable. Porta cuenta a tono.

**PT** Suporta para menu de madeira pressionada, com mola em aço inoxidável. Porta contas disponível no mesmo formato.

**NL** Hardboard, sterke veerklem in roestvrij staal. Rekeninghouder in bijpassende stijl.



1

A4

1 10 40

1 MC-CBA4-BR 34,6x23,1x4,6cm 0,3kg

2 MC-CBBP-BR 28x11,7x3cm 0,1kg



2



# CRYSTAL RANGE



Flexible, easy to clean, stitched edges, metal corner protectors, anti-reflective doublesided insert holders.

**FR** Protège-menus double-face, anti-reflets, souples, faciles à nettoyer, bords cousus, coins de protection en métal.

**DE** Flexible, einfach zu reinigende Speisekarte mit gestickten Rändern und Metallecken. Matte, nicht reflektierende, doppelseitige Oberfläche.

**IT** Porta menù trasparente, flessibile, facile da pulire, bordi rifiniti, angoli protettivi in metallo, inserti antiriflesso. Utilizzabili su entrambi i lati.

**ES** Porta menù, flexible, fácil de limpiar, con bordes cosidos, protectores de esquinas de metal y fundas antirreflejo utilizables en ambas caras.

**PT** Suportes para menu bilaterais, transparentes e anti-reflexos. Proteções de cantos em metal, e bordas costuradas. Fléxivel e fácil de limpar.

**NL** Flexibel, eenvoudig te reinigen, gestikte randen, metalen hoekbeschermers, anti-reflecterende dubbelzijdige menuhouders.

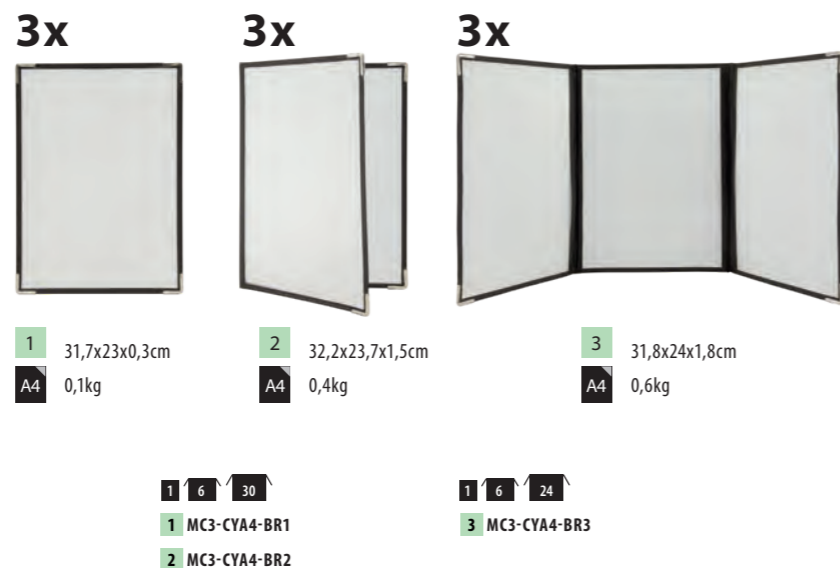

# MAGNETIC MENU HOLDER

Polyurethane holder with magnetic side clamps to hold inserts. Available in two colours.

**FR** Protège-menu en polyuréthane avec des bandes magnétiques sur le côté, pour maintenir les inserts. Disponible en deux couleurs.

**DE** Polyurethan Speisekarte mit umklappbaren, magnetischen Rändern zum Befestigen des Menüs. In 2 Farben erhältlich.

**IT** Porta menù in similpelle con parti magnetiche laterali per sostenere il menù. Disponibile in due colori.

**ES** Porta menù de simil cuero PU con lados magnéticos para sujetar las fundas de forma segura. Disponible en dos colores.

**PT** Suporte para menu com efeito pele, com lados magnéticos que permitem suportar as micas. Disponível em duas cores.

**NL** Menukaart in polyurethaan met magnetische zijklems om menu's vast te houden. Verkrijgbaar in twee kleuren.

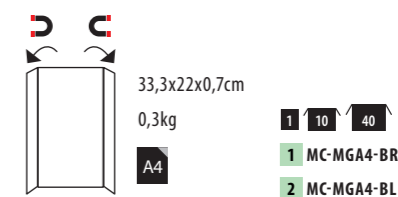
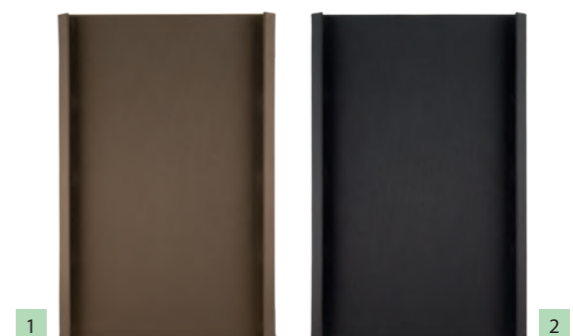

# LED RANGE

Polyurethane menu holder frame, rechargeable built-in battery, USB charging cable included. Illuminates pages automatically when opened. Up to 8 hours power, average 2 weeks usage.

**FR** Cadre en polyuréthane, avec batterie rechargeable intégrée, câble de charge avec port USB inclus. Illumine automatiquement les pages lors de l'ouverture de la carte-menu. Jusqu'à 8 heures d'autonomie, 2 semaines d'utilisation en moyenne.

**DE** LED-Speisekarten aus Polyurethan mit Rahmen und wiederaufladbarer Batterie. Inklusive USB-Ladekabel. Beleuchtet die Seiten automatisch beim Öffnen der Karte. Betrieb bis zu 8 Stunden. Nutzung durchschnittlich 2 Wochen.

**IT** Porta menù a LED in similpelle, batteria integrata ricaricabile, cavo USB incluso. Illumina le pagine automaticamente quando viene aperto. Fino a 8 ore di luce e con una media di 2 settimane di autonomia.

**ES** Porta menù LED de simil cuero PU, con batería recargable incorporada y cable USB incluido. Ilumina automáticamente las páginas cuando se abre. Hasta 8 horas de energía, promedio de 2 semanas de autonomía.

**PT** Suporte para menu LED e com efeito pele que iluminam inserções automaticamente quando abertos. Bateria recarregável e carregador USB incluídos. Capacidade de bateria com duração até 8 horas.

**NL** Menukaart met een frame van polyurethaan, oplaadbare ingebouwde batterij, inclusief USB-oplaadkabel. Verlicht pagina's automatisch wanneer ze worden geopend. Tot 8 uur stroom, gemiddeld gebruik van 2 weken.



1 A4S 35,3x18,8x1,8cm 0,7kg

2 A4 35,2x26,4x1,8cm 1,0kg

3 A4 35,5x25,8x0,8cm 0,5kg

**Additional multi-plug USB charger available.**

**FR** Chargeur multiprise USB supplémentaire disponible. **DE** Ladestation mit mehreren USB Anschlüssen separat erhältlich. **IT** Caricabatteria aggiuntivo USB multi-spina disponibile. **ES** Cargador adicional USB de varios enchufes disponible. **PT** Carregador adicional multi-plug USB disponível. **NL** USB-oplader met meerdere pluggen apart beschikbaar.

**Use with the Securit® transparent insert foils.**

**FR** À utiliser avec les inserts de feuilles transparentes Securit®. **DE** Bedruckbare Folien für Tintenstrahl- oder Laserdrucker separat erhältlich. **IT** Da utilizzare con gli inserti trasparenti Securit®. **ES** Para utilizar con los insertos Securit®. **PT** Para utilizar com inserções Securit®. **NL** Gebruik met de Securit® transparante inzetfolies.



1 x x  
4x13x3cm 0,5kg  
4 MC-LD-MC10



20x

1 6 30  
5 MC-LIA4-LJ | Laser printer  
6 MC-LIA4-IJ | Inkjet printer



1 x 3  
1 MC-LD45-BL  
2 MC-LDA4-BL  
3 MC-LDSP-BL

1 x 3  
1 MC-LD45-SL  
2 MC-LDA4-SL  
3 MC-LDSP-SL

1 x 3  
1 MC-LD45-CP  
2 MC-LDA4-CP  
3 MC-LDSP-CP

# BILL PRESENTERS

PORTE-ADDITIONS - RECHNUNGSMAPPEN - PORTACONTO  
 PORTA CUENTAS - PORTA CONTA - REKENINGHOUDERS

## Stainless Steel



1 10 40  
 MC-BP-BSS 18x9x0,7cm 0,1kg

## Walnut Range

> pg. 112



1 10 40  
 MC-WALBP-BL 24x10x1,4cm 0,1kg

## Classic Range

> pg. 93



1 10 40  
 MC-CRBP-BL 23,9x13,1x0,5cm 0,1kg

## Trendy Range

> pg. 95



1 10 40  
 MC-TRBP-BL 23,4x12,8x0,5cm 0,1kg

## Treasure Box



1 10 40  
 MC-BPBOX-AN 11x15,8x11,4cm 0,3kg

## Block



1 10 40  
 MC-BPBLOCK-TE 7x8x8cm 0,2kg

## Basic Range

> pg. 109



1 10 40  
 MC-BRBP-BL 23,7x12,5x0,5cm 0,1kg

## Clipboard Range

> pg. 117



1 10 40  
 MC-CBBP-BR 28x11,7x0,3cm 0,1kg

# BILL PRESENTERS

PORTE-ADDITIONS - RECHNUNGSMAPPEN - PORTACONTO  
PORTA CUENTAS - PORTA CONTA - REKENINGHOUDERS

## Leather Range

> pg. 90

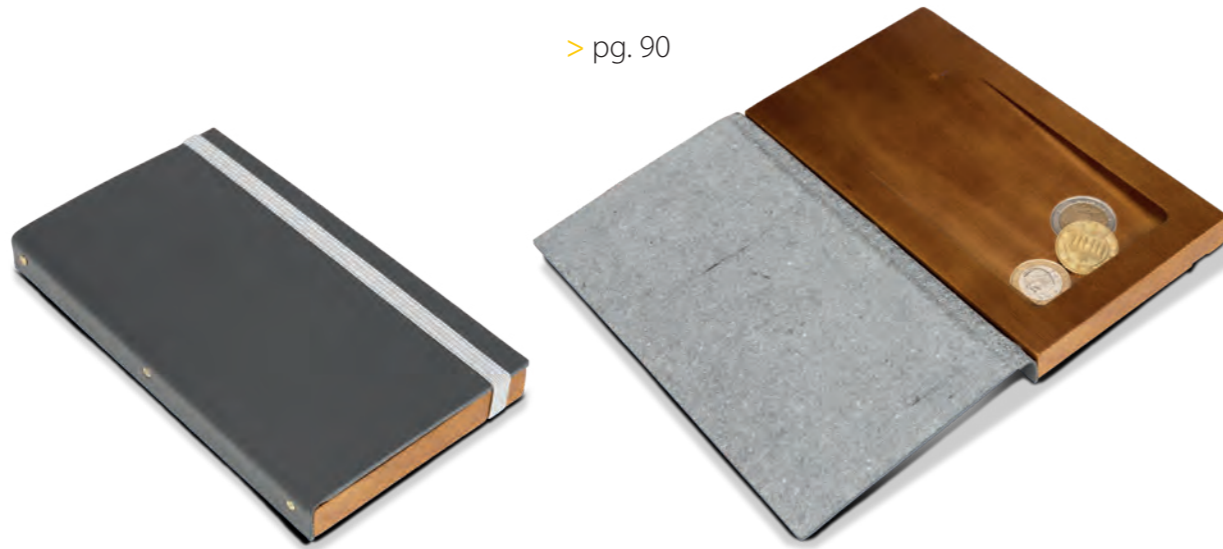

**1** **10** **40**  
MC-DBBP-GY 18,4x10,4x2cm 0,1kg

## Trendy Range

> pg. 95



**1** **10** **40**  
MC-DBBP-BL 18,4x10,4x2cm 0,1kg

**1** **10** **40**  
MC-BPBOX-TR 18,3x12,5x4xcm 0,2kg

# VINTAGE WOODEN CRATES



1

2 \*

3 \*\*

Wooden crates in lightweight, strong, lacquered paulownia wood. Available as a classic wooden crate in two different sizes or with a chalkboard writing surface on two sides, suitable for writing with Securit® Chalk Markers. \*Sold in a flat pack, assembly screws included. \*\*Sold already assembled.

**FR** Caisnes légères et résistantes, en bois de paulownia laqué. Disponible en tant que caisse en bois classique, en deux tailles différentes ou avec une surface d'écriture ardoise sur deux côtés. Adaptée à l'écriture avec les feutres-craie Securit®. \*Vendu en paquet plat, vis d'assemblage incluses. \*\*Vendu déjà assemblé.

**DE** Vintage Kiste aus leichtem, stabilem, lackiertem Paulownia Holz. Erhältlich als klassische Holzkiste in 2 Größen oder Holzkiste mit Kreidetafeln an zwei Seiten, geeignet zum Beschreiben mit Securit® Kreidestiften. \*Verpackt in einer flachen Verpackung mit Schrauben. \*\*Vollständig montiert.

**IT** Cassete in legno di paulownia laccato, leggera e resistente. Disponibile come cassa di legno classica in due misure diverse o con una lavagna sui due lati, adatta per scrivere con i pennarelli a gesso liquido Securit®. \*Venduta smontata con viti di montaggio incluse. \*\*Venduta già assemblata.

**ES** Cajas de madera de paulownia lacada, ligera y resistente. Disponible como caja de madera clásica en dos tamaños diferentes o con una pizarra en dos lados. Ideal para su escritura con marcadores de tiza líquida Securit®. \*Vendido en paquete plano, incluye tornillos para su armado. \*\*Vendido ya armado.

**PT** Caixas clássica em paulownia lacada, leve e forte. Disponível como caixa de madeira clássica em dois tamanhos diferentes ou com quadro com duas faces para escrita, apto para escrever com os marcadores a giz Securit®. \*Produto vendido por montar, a embalagem inclui parafusos para a montagem. \*\*Produto vendido já montado.

**NL** Houten kratten van lichtgewicht, sterk, gelakt paulowniahout. Verkrijgbaar als een klassieke krat in twee verschillende maten, of met een beschrijfbaar krijtbord aan twee kanten, geschikt voor Securit® krijtstiften. \* Verkocht in een platte verpakking, inclusief montageschroeven. \*\* Reeds gemonteerd.

**1** **x** **6**  
**1** CR-CB 21x28,3x35cm 0,9kg  
**2** CR-VIN 21x24,2x33cm 0,7kg  
**3** CAD-VIN 11,6x24x14,2cm 0,2kg



# POSTER FRAMES & SIGNS

- FR** PORTE-AFFICHES & SIGNALISATION
- DE** DISPLAYS & SCHILDER
- IT** CORNICI PORTA POSTER & INSEGNE
- ES** MARCOS PARA PÓSTERS & CARTELES
- PT** MOLDURAS PARA POSTERS & SINAIS
- NL** POSTERHOUDERS & VERWIJSBORDEN

# NEW BROCHURE HOLDERS

Easy to clean acrylic brochure holders. Available in free-standing, hanging or wall models. In multiple variants to hold business cards and brochures for formats of A5 and A4.

**FR** Porte-brochures en acrylique, facile à nettoyer. Disponibles en modèles autoportants, suspendus ou muraux. En plusieurs variantes pour contenir des cartes de visite et des brochures aux formats A5 et A4.

**DE** Leicht zu reinigende Prospekthalter aus Acryl. Erhältlich in Stand-, Hänge- und Wandmodell. In verschiedenen Varianten erhältlich um Visitenkarten und Broschüren in den Formaten A5 und A4 zu präsentieren.

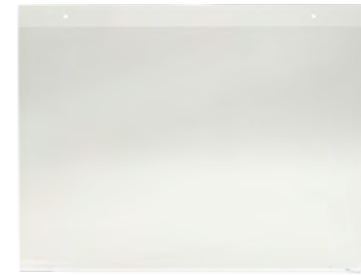

A4 1



A4 2

**IT** Porta brochures in acrilico facili da pulire. Disponibili in modelli da tavolo, da appendere o da montare a muro. In più varianti per contenere biglietti da visita e brochures per i formati A5 e A4.

**ES** Portafolletos acrílicos fáciles de limpiar. Disponibles en modelos de pie, colgantes o de pared. En múltiples variantes para poner tarjetas de visita y folletos para formatos A5 y A4.

**PT** Suportes de brochuras em acrílico fáceis de limpar. Disponíveis em modelos de pé livre, pendurados ou de parede. Em múltiplas variantes para guardar cartões de visita e brochuras para formatos de A5 e A4.

**NL** Eenvoudig te reinigen brochurehouders van acryl. Verkrijgbaar in vrijstaande, hangende of wandmodellen. In meerdere varianten voor visitekaartjes en brochures voor formaten A5 en A4.

1 10 40

- 1 PFT-BRO-HHA4 23,3x29,8x0,5cm 0,3kg
- 2 PFT-BRO-HVA4 32x21x0,5cm 0,3kg

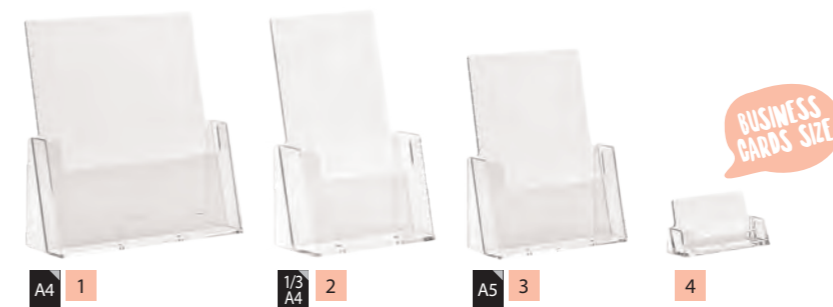

A4 1 1/3 A4 2 A5 3 4

BUSINESS CARDS SIZE

- 1 x 8  
1 PFT-BRO-A4 23,3x25,5x8cm 0,3kg
- 1 x 14  
2 PFT-BRO-TA4 11x18x6,5cm 0,1kg
- 1 x 16  
3 PFT-BRO-A5 16,5x22x7,5cm 0,1kg
- 4 PFT-BRO-BC 5x10x3,5cm 0,1kg

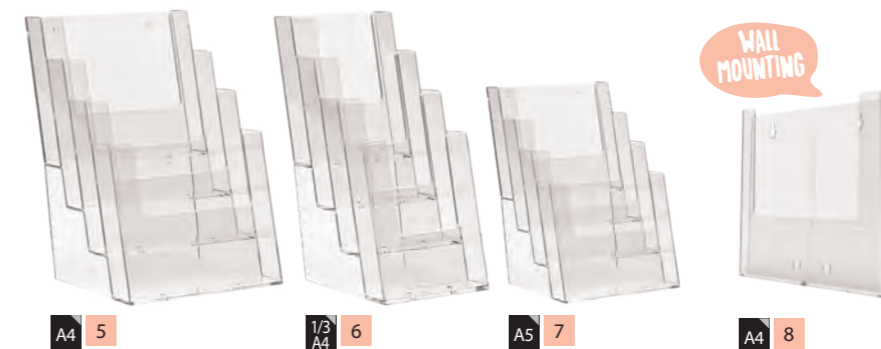

A4 5 1/3 A4 6 A5 7 A4 8

WALL MOUNTING

- 1 2 8  
5 PFT-BRO-4A4 17,5x24x34cm 0,9kg
- 1 4 20  
6 PFT-BRO-4TA4 18x25,5x11,5cm 0,3kg
- 1 2 18  
7 PFT-BRO-4A5 20x26x16,5cm 0,5kg
- 1 x 10  
8 PFT-BRO-WA4 23,5x24,5x3,7cm 0,3kg

# ACRYLIC POSTER FRAMES

Free-standing, easy to clean acrylic poster frames. Double-sided poster holders are available in four sizes, triple-sided table displays are available in two sizes.

**FR** Porte-affiche en acrylique, autoportants et faciles à nettoyer. Les porte-affiches double-face sont disponibles en quatre tailles. Les présentoirs de table triple-face sont disponibles en deux tailles. **DE** Leicht zu reinigender Acryl-Tischaufsteller. Doppelseitige Tischaufsteller gibt es in vier Größen, dreiseitige Aufsteller in zwei Größen. **IT** Porta poster realizzati in acrilico facili da pulire. I porta poster a due lati sono disponibili in quattro formati mentre quelli a tre lati sono disponibili in due formati. **ES** Marcos de acrílico fáciles de limpiar. Los marcos de doble cara están disponibles en cuatro tamaños y los triple cara están disponibles en dos tamaños. **PT** Molduras de cartazes em acrílico, de fácil limpeza. Os suportes para cartazes de dupla face estão disponíveis em quatro tamanhos, os expositores de mesa de tripla face estão disponíveis em dois tamanhos. **NL** Vrijstaande, eenvoudig te reinigen acryl poster frames. Dubbelzijdige reclame houders in vier maten verkrijgbaar, driezijdige tafel displays verkrijgbaar in twee maten.



# STAINLESS STEEL POSTER FRAMES

Easy to clean, double-sided acrylic table displays with stainless steel base. Available in three sizes.

**FR** Porte-affiche en acrylique, double face, faciles à nettoyer, avec base en acier inoxydable. Disponible en trois tailles.

**DE** Acryl-Tischaufsteller mit Edelstahlfuß. Doppelseitig und einfach zu reinigen. Erhältlich in verschiedenen Größen.

**IT** Porta poster da tavola in acrilico utilizzabile su due lati, facile da pulire e con base in acciaio inossidabile. Disponibile in tre formati.

**ES** Porta póster de mesa hecho en acrílico con base de acero inoxidable. Utilizable sobre dos lados, fácil de limpiar. Disponible en tres tamaños. **PT** Suporte para cartazes de mesa em acrílico com base em aço inoxidável. Utilizável em dois lados, fácil de limpar. Disponível em três tamanhos. **NL** Eenvoudig te reinigen, dubbelzijdige posterhouders van acryl met roestvrijstalen voet. Verkrijgbaar in drie maten.

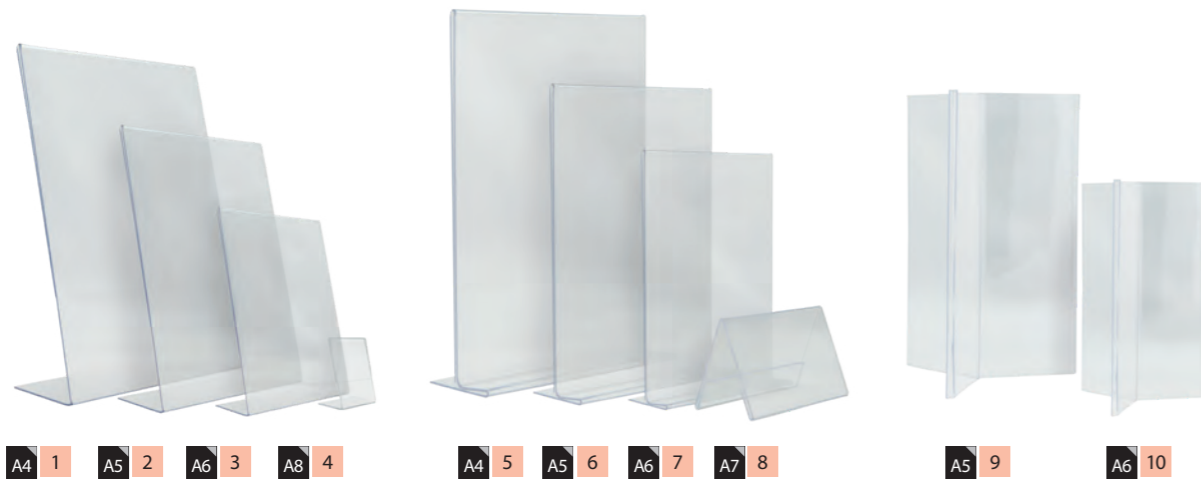

A4 1 A5 2 A6 3 A8 4



A4 5 A5 6 A6 7 A7 8



A5 9 A6 10

- 1 6 36
- 1 PFT-ACL-A4 32x21,2x8,1cm 0,2kg
- 2 PFT-ACL-A5 21,4x15,1x7,4cm 0,1kg
- 3 PFT-ACL-A6 15x10,5x5cm 0,1kg

- 1 x 12
- 4 PFT-ACL-A8 8x4,1x4,1cm 0,02kg

- 1 6 36
- 5 PFT-ACV-A4 30x21x8,5cm 0,3kg
- 6 PFT-ACV-A5 21,3x15x5,4cm 0,1kg
- 7 PFT-ACV-A6 15,5x10,7x4,7cm 0,1kg

- 1 x 12
- 8 PFT-ACV-A7 7,8x10,6x6,7cm 0,05kg

- 1 x 36
- 9 PFT-ACY-A5 21x13,5x13,5cm 0,2kg
- 10 PFT-ACY-A6 15x9,5x9,5cm 0,1kg



A6 3 A5 2 A4 1

- 1 6 18
- 1 PFT-ACM-A4 31,8x21x7,4cm 0,44kg
- 2 PFT-ACM-A5 23x15x7,4cm 0,26kg
- 3 PFT-ACM-A6 17,3x10,5x7,4cm 0,23kg

STAINLESS STEEL



- |   |            |                 |        |
|---|------------|-----------------|--------|
| 1 | 6          | 12              |        |
| 1 | PFT-MAG-A4 | 21x29,7x1,6cm   | 1,1kg  |
| 1 | 6          | 24              |        |
| 2 | PFT-MAG-A5 | 14,8x21x1,6cm   | 0,6kg  |
| 1 | 6          | 36              |        |
| 3 | PFT-MAG-A6 | 10,5x14,8x1,2cm | 0,2kg  |
| 1 | 12         | 120             |        |
| 4 | PFT-MAG-A7 | 7,4x10,5x1cm    | 0,1kg  |
| 5 | PFT-MAG-A8 | 5,2x7,4x1cm     | 0,05kg |

Acrylic poster frame to use as a single or double-sided frame. Two blocks with strong magnets in each corner to hold the two sides together. Can be used in a horizontal or vertical position.

**FR** Porte-affiche en acrylique à utiliser comme cadre simple ou double face. Deux blocs avec des aimants puissants à chaque coin, pour maintenir les deux côtés ensemble. Peut être utilisé en position horizontale ou verticale.

**DE** Magnetischer transparenter Acryl-Rahmen. Doppelseitig verwendbar. Die beiden Acryl Blöcke werden von einem starken Magneten in jeder Ecke zusammengehalten. Kann sowohl in horizontaler als auch vertikaler Position verwendet werden.  
**IT** Cornice porta poster in acrilico da utilizzare come cornice singola o doppia. Potenti magneti posizionati ad ogni angolo capaci di tenere uniti i due lati. Può essere utilizzato sia in posizione orizzontale che verticale.  
**ES** Marco acrílico para pósters para usar en una o dos caras. Dos bloques con imanes fuertes en cada esquina

mantienen los dos lados juntos. Se puede posicionar horizontal o verticalmente.  
**PT** Moldura de póster acrílica para uso em um ou dois lados. Com imãs fortes em cada canto para mantê-los os dois lados juntos. Pode ser posicionado horizontalmente ou verticalmente.  
**NL** Acryl posterframe die zowel enkel- als dubbelzijdig te gebruiken is. Twee blokken met sterke magneten in elke hoek om de twee kanten bij elkaar te houden. Kan in horizontale of verticale positie worden gebruikt.



A4 1 A5 2 A6 5

Hard lacquered, all-weather resistant beechwood base. Double-sided, easy to clean acrylic posterholder included. Available in three styles and sizes.

**FR** Base en bois de hêtre laquée, résistante aux intempéries. Porte-affiche en acrylique double-face, facile à nettoyer, inclus. Disponible en deux modèles différents et trois tailles possibles.



A4 3 A5 4 A6 6

**DE** Acryl Tischaufsteller mit Buchenholzfuß. Allwetterbeständig, doppelseitig und einfach zu reinigen. Erhältlich in drei Ausführungen und Größen.  
**IT** Porta poster con base in legno di faggio laccato resistente agli agenti atmosferici. Include una lastra in acrilico utilizzabile su due lati, facile da pulire. Disponibile in tre stili e formati.  
**ES** Marco para carteles con base de madera de cacho, resistente a cualquier tipo de clima. Incluye una funda rígida de acrílico, fácil de limpiar. Disponible en tres estilos y tamaños.

- |   |           |               |       |
|---|-----------|---------------|-------|
| 1 | x         | 6             |       |
| 1 | PFT-BL-LA | 32,3x27,1x7cm | 0,5kg |
| 2 | PFT-BL-ME | 24x20x6cm     | 0,3kg |
| 3 | PFT-TE-LA | 32,3x27,1x7cm | 0,5kg |
| 4 | PFT-TE-ME | 24x20x6cm     | 0,3kg |
| 1 | x         | 10            |       |
| 5 | PFT-BL-SM | 17,4x15,7x5cm | 0,2kg |
| 6 | PFT-TE-SM | 17,4x15,7x5cm | 0,2kg |

**PT** Molduras de cartazes com base de madeira endurecida, lacada e resistente a todo o tipo de tempo. Moldura de poster transparente incluída, bilateral e fácil de limpar. Disponível em três estilos e tamanhos diferentes.  
**NL** Hard gelakt, weerbestendige beukenhouten voet. Eén dubbelzijdige acryl posterhouder inbegrepen, eenvoudig te reinigen. Verkrijgbaar in drie stijlen en maten.



## WINDOW SIGNAGE

Precision cut, flexible, double-sided window signage. UV, shock, stain and scratch resistant. Integrated suction cups for mounting on glass surfaces. Available with a chalkboard writing surface or as a A3 and A4 transparent poster frame.

**FR** Signalisation pour vitrine, double-face, flexible et découpée avec précision. Résistante aux UV, chocs, tâches et rayures. Ventouses intégrées pour un montage sur des surfaces en verre. Disponible avec une surface d'écriture ardoises ou comme cadre transparent pour affiches A3 et A4.

**DE** Präzise geformte, flexible und einfach zu reinigende doppelseitige Fensterbeschilderung. UV-, stoß-, schmutz- und kratzbeständig. Integrierte Saugnäpfe zur Befestigung auf Glasflächen und Fliesen. Erhältlich als Kreidetafel oder als transparenter Posterrahmen in A3 und A4.

**IT** Lavagna flessibile con ventose per superfici in vetro. Resistente ai raggi UV, agli urti, alle macchie e ai graffi. Superficie di scrittura utilizzabile su entrambi i lati e facile da pulire. Disponibile con superficie di scrittura o come cornice trasparente per poster A3 e A4.

**ES** Pizarra para vidrios con ventosas, superficie de escritura flexible, utilizable en ambas caras, fácil de limpiar. Resistente a los rayos UV, golpes, manchas y rayones. Disponible con superficie de escritura o como marco de póster transparente A3 y A4.

**PT** Quadro com ventosas que permitem a colocação em superfícies de vidro, superfície de escrita flexível, utilizável em ambos os lados, fácil de limpar. Resistente a quedas, manchas, arranhões, e UV. Disponível com superfície de escrita ou como moldura de cartaz transparente A3 e A4.

**NL** Strak uitgesneden, flexibele, dubbelzijdige raamdisplays. UV-, schok-, vlek- en krasbestendig. Geïntegreerde zuignappen voor montage op glazen oppervlakken. Beschikbaar met een beschrijfbaar krijtbord of als transparante posterframe in A3 en A4 formaat.



1 6 24  
36x27,1x0,2cm 0,2kg

1 PFW-A4-GY  
2 PFW-A4-BL  
3 PFW-A4-YE

1 x 6  
52,3x39,8x0,2cm 0,5kg

4 PFW-A3-GY  
5 PFW-A3-BL  
6 PFW-A3-YE



1 6 36  
7 PFW-27-36-BL 35,6x27,1x0,3cm 0,2kg

## SIGNAGE

Stainless steel, self-adhesive signs. Use on walls, doors and/or other flat surfaces. Set of six different indications.

**FR** Pictogramme sur plaque en acier inoxydable, avec fixation auto-adhésive. À plaquer sur mur, porte ou toutes autres surfaces plates. Lot de 6 pictogrammes différents.

**DE** Selbstklebende Informationsschilder mit verschiedenen Symbolen aus Edelstahl. Für die Nutzung an Wänden, Türen und/oder glatten Oberflächen. 6 verschiedene Motive in einer Verpackung.

**IT** Targhette adesive in acciaio inox da posizionare su muri, porte e altre superfici lisce. Set di 6 targhette con diversi simboli.

**ES** Placas autoadhesivas en acero inoxidable para adherencia sobre paredes, puertas y otras superficies planas. Set de 6 placas con íconos diferentes.

**PT** Sinais em aço inoxidável com auto-adesivos. Para utilização em paredes, portas e/ou outras superfícies planas. Conjunto de 6 sinais diferentes.

**NL** Roestvrij staal, zelfklevende borden. Gebruik op muren, deuren en/of andere vlakke oppervlakken. Set van zes verschillende indicaties.



1 6 60  
SI-SS-SET 10x10x1,2cm 0,3kg



## POWERBANK POSTER FRAME

13000 mAh



1 x 6

PFT-PWB 27,7x16,2x7,8cm 0,5kg

Double-sided table display with powerbank. ABS thermoplastic structure, stain and scratch resistant, easy to clean. Rechargeable battery (13.000 mAh lithium) can last up to 10 hours. Rechargeable with the included USB cable. Three-way plug phone charging cable included. Suitable for all mobile phones and tablets.

**FR** Porte-affiche de table, double-face avec chargeur. Structure thermoplastique ABS, résistante aux tâches et aux rayures, facile à nettoyer. La batterie rechargeable (lithium 13.000 mAh) peut durer jusqu'à 10 heures. Rechargeable avec le câble USB inclus. 1 câble de chargement avec trois embouts différents inclus. Convient à tous les téléphones mobiles et tablettes.

**DE** Doppelseitiger Acryl Tischaufsteller mit Powerbank. ABS thermoplastische Struktur, leicht zu reinigen, schmutz- und kratzfest. Der wiederaufladbare Akku (13.000 mAh Lithium) hält bis zu 10 Stunden. Aufladbar mit dem mitgelieferten USB-Kabel. 3 in 1 USB-Ladekabel inklusive. Geeignet für Mobiltelefone und Tablets.

**IT** Porta poster caricabatteria da tavola, struttura termoplastica ABS, resistente alle macchie e ai graffi, facile da pulire. Batteria ricaricabile al litio 13.000 mAh con una durata fino a 10 ore. Ricaricabile con il cavo USB incluso con 3 spine diverse. Adatto a tutti i telefoni cellulari e tablet.

**ES** Porta póster y cargador de mesa con estructura termoplástica ABS, resistente a manchas y rayones, fácil de limpiar. Batería recargable de litio 13.000 mAh dura hasta 10 horas. Incluye un cable de carga USB con 3 enchufes diferentes. Carga todo tipo de teléfono móvil y tablets.

**PT** Display de mesa com carregador. Estrutura termoplástica em ABS, resistente a manchas e riscos; fácil de limpar. Bateria recarregável de Lítio 13.000 mAh, com duração até 10 horas. Recarregável com cabo USB (incluído). Cabo com 3 fichas de saída incluído. Adequado para todos os telemóveis e tablets.

**NL** Dubbelzijdige tafel display met powerbank. ABS-thermoplastische structuur, vlek- en krasbestendig, eenvoudig te reinigen. Oplaaadbare batterij (13.000 mAh lithium) kan tot 10 uur meegaan. Oplaabaar met meegeleverde USB-kabel. Drieweg plug-in telefoon oplaadkabel inbegrepen. Geschikt voor alle mobiele telefoons en tablets.



## LED SIGNS

For mounting on wall or window, max. 4-colour flashing light options. 220 v AC adaptor and 130 cm power cable included. Available in three designs.

**FR** Pour suspension murale ou sur vitrine, 4 options maximales de couleurs et lumières clignotantes. Adaptateur 220 V AC et câble d'alimentation de 130 cm inclus. Disponible en 3 modèles.

**DE** LED-Schilder zum Anbringen an Wänden oder Fenstern, max. 4-farbige Blinklichtoptionen. 220 v AC Adapter und 130 cm Netzkabel inklusive. Verfügbar in drei Ausführungen.

**IT** Insegna luminosa a LED da appendere al muro o vetrina. Realizzata con LED lampeggianti in 4 colori. Include un adattatore a 220 v AC ed un cavo di 130 cm. Disponibile in 3 stili.

**ES** Letrero luminoso LED para montaje sobre pared o vitrinas. Tiene luces intermitentes en 4 colores. Incluye adaptador 220 v AC y cable de 130 cm. Disponible en 3 diseños.

**PT** Sinal LED para montagem na parede ou em vitrina. Tem luzes intermitentes em 4 cores. Inclui adaptador AC de 220 v e cabo de 130 cm. Disponível em 3 desenhos.

**NL** Voor montage op muur of raam, max. 4-kleuren knipper licht opties. 220 v AC-adapter in 130 cm stroomkabel meegeleverd. Verkrijgbaar in drie ontwerpen.

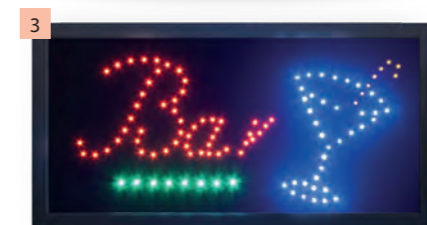
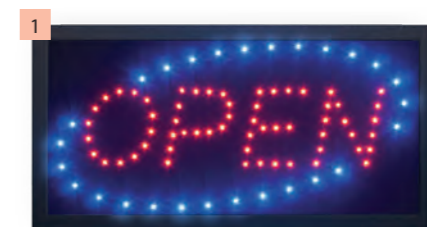

1 x 6

24x48x2cm 0,7kg

1 LS-OPEN

2 LS-PIZZA

3 LS-BAR



# INFORMATION DISPLAYS

- FR** PRÉSENTOIRS PORTE-MENUS
- DE** INFORMATIONS-/MENÜKARTENDISPLAYS
- IT** ESPOSITORI INFORMATIVI
- ES** EXPOSITORES DE INFORMACIÓN
- PT** EXPOSITORES DE INFORMAÇÃO
- NL** INFORMATIEDISPLAYS

# BLACK STAR XXL



All-weather resistant black hammertone steel display with lock system and floor-protection. Extra bright LED lights activated by a remote control (included). Power plug and five-metre cable included. Compatible with the Securit® Battery Pack (available separately). Metal panel and magnets included to position paper inside. To be mounted on wall (bolts included) or on Securit® poles and base of 110 cm with wheels and with additional two metal bars\* for extra stability.

**FR** Porte-menu en acier noir martelé, résistant aux intempéries, avec un système de verrouillage et de protection du sol. Lumières LED très brillantes activées par une télécommande (incluse). Adaptateur et câble de cinq mètres inclus. Compatible avec le Pack batterie Securit® (disponible séparément). Panneau métallique et aimants inclus pour positionner le papier à l'intérieur. À fixer au mur (boulons inclus) ou sur des pieds Securit® avec un socle de 110 cm, avec roues. Vous trouverez également deux barres métalliques supplémentaires\*, sur le devant du socle, à positionner pour plus de stabilité.

**DE** Witterungsbeständiges Edelstahl-Display mit schwarzer Hammerschlaglackierung, Schlosssystem und Bodenschutz. Mit besonders heller LED Beleuchtung, inkl. Fernbedienung. Inklusive Netzstecker mit 5 Meter langem Kabel. Kompatibel mit Securit® Batterien (separat erhältlich). Magnetische Platte und Magnete zur Befestigung des Papiers inklusive. Sowohl für die Wandmontage (Schrauben inkludiert), als auch zur Montage auf dem stabilen Securit® Pfosten und Fuß von 110 cm mit Rollen geeignet. Inklusive zwei zusätzlichen Metallstangen\* für zusätzliche Stabilität.

**IT** Espositore in acciaio nero, resistente agli agenti atmosferici, con sistema di chiusura a chiave e con base anti-graffio. Illuminazione a LED attivabile con un telecomando (incluso) e presa di alimentazione e cavo di 5 metri (inclusi). Compatibile con la batteria a litio ricaricabile Securit® (disponibile separatamente). Pannello metallico e magneti inclusi per posizionare il menù all'interno. Può essere agganciato al muro (kit di montaggio incluso) o posizionato su una base di 110 cm con ruote e due colonnine Securit®. La base include due barre metalliche aggiuntive\* per una maggiore stabilità.

**ES** Expositor recubierto en acero negro, tono martillo, resistente a la intemperie, con sistema de cierre y base anti-rayones para protección del piso. Incluye luces LED blancas extra brillantes, control remoto, cable de 5 metros y enchufe. Compatible con la batería Securit® (disponible por separado). Panel metálico e imanes incluidos para colocar el menù en el interior. Puede ser montado sobre pared (tornillos incluidos) o sobre set de base con ruedas y postes Securit® (110 cm). \*La base incluye dos barras de metal adicionales para estabilidad extra.

**PT** Expositor LED com revestimento em aço inoxidável preto, resistente a todas as intempéries com fecho de chave e protecção do chão. Luzes LED extra brilhantes activadas por um controlo remoto (incluídas). Ficha de alimentação e cabo de cinco metros incluído. Compatível com o pacote de Bateria Securit® (disponível em separado). Painel metálico e ímanes incluídos para posicionar o menu no interior. Para ser montado na parede (parafusos incluídos) ou em postes e base Securit® de 110 cm com rodas e com duas barras metálicas adicionais\* para maior estabilidade.

**NL** Weerbestendig hamerslag zwart stalen display met vergrendelingsysteem. Extra heldere LED-verlichting te bedienen met een afstandsbediening (inbegrepen). Stekker en kabel van 5 meter inbegrepen. Compatibel met het Securit®-batterijpakket (apart verkrijgbaar). Metalen paneel en magneten inbegrepen om papier binnenin te plaatsen. Te monteren op muur (inclusief bouten) of op Securit®-palen en voet van 110 cm met wielen.

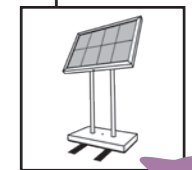
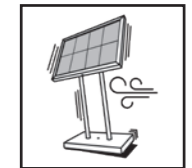
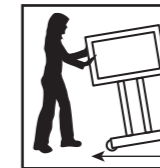
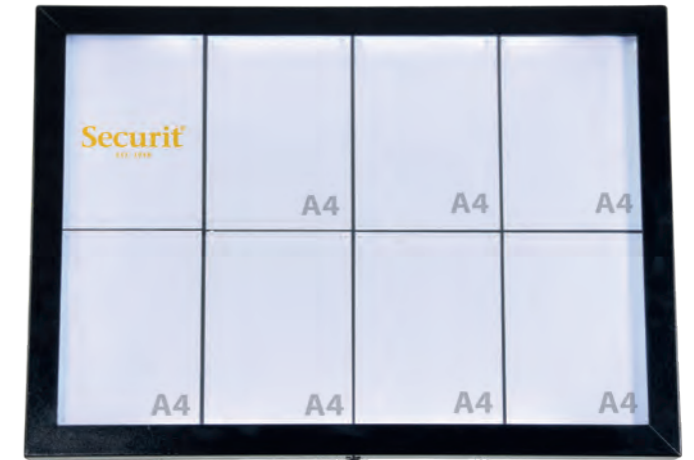

EXTRA STABILITY



4 >10h

1 x x x

1 MCS-8A4-BL 92x5,5x67cm 21kg

3 MCS-BA-BL2 75x45x7cm 23kg

1 x x x

2 MCS-BA-110-BL1 112x6x6cm 5kg

1 x x 24

4 MCS-BATT 16,5x7,5x1,3cm 0,3kg

SKU/item Inner Master



## BLACK STAR

All-weather resistant black-coated steel display with lock system and white LED lights. Remote control, mounting pole and base, power plug and five-metre cable included. Compatible with Securit® Battery Pack (available separately). Metal panel and magnets inside.

**FR** Porte-menu en acier revêtu de noir, résistant aux intempéries, avec système de verrouillage et lumières LED blanches. Télécommande, pied et socle de support, adaptateur et câble de cinq mètres inclus. Compatible avec le Pack batterie Securit® (disponible séparément). Panneau métallique et aimants à l'intérieur.

**DE** Witterungsbeständiges schwarz beschichtetes Edelstahl-Display mit Schlosssystem. Mit besonders heller weißer LED Beleuchtung, inkl. Fernbedienung, Pfosten und Fuß, sowie Netzstecker und 5 Meter langem Kabel. Kompatibel mit Securit® Batterien (separat erhältlich). Magnetische Platte und Magnete zur Befestigung des Papiers inklusive.

**IT** Espositore in acciaio inox verniciato nero resistente agli agenti atmosferici, con sistema di chiusura a chiave e luci a LED bianche. Telecomando, base e colonnina, presa di alimentazione e cavo di 5 metri inclusi. Compatibile con la batteria Securit® (disponibile separatamente). Pannello metallico e magneti all'interno.

**ES** Expositor de acero inoxidable recubierto en color negro resistente a la intemperie, con sistema de cierre y luces LED blancas. Incluye control remoto, poste y base para su montaje, enchufe y cable de 5 metros. Compatible con la batería Securit® (no incluida). Panel metálico e imanes en el interior.

**PT** Expositor em aço inoxidável revestido a preto à prova de intempéries com sistema de fecho e luzes LED brancas. Inclui controlo remoto, poste e base para montagem, ficha e cabo de 5 metros. Compatível com a bateria Securit® (não incluída). Painel metálico e imanes no interior.

**NL** Weerbestendig zwart gelakt stalen display met vergrendeling en witte LED-verlichting. Afstandsbediening, montage paal en voet, adapter en 5 meter kabel inbegrepen. Bruikbaar met Securit®-batterij (apart beschikbaar). Metalen paneel en magneten binnenin.



**Wheels not included with display.**

**FR** Paire de roulettes non incluses avec le porte-menu.  
**DE** Rollen separat erhältlich.  
**IT** Ruote non incluse.  
**ES** Ruedas no incluidas.  
**PT** Rodas não incluídas.  
**NL** Wielen niet inbegrepen bij display.



1 x x

1 MCS-4A4-BL-SET 138x50x40cm 24,7kg

1 x 24

2 MCS-WH-2 5,5x12x9cm 0,8kg

1 x 24

3 MCS-BATT 16,5x7,5x1,3cm 0,3kg



All-weather resistant stainless steel display case with lock system. Twenty LED colours and 5 light style options with 10 light intensity settings. Power plug, five-metre cable and remote control included. To be mounted on the wall (bolts included) or on Securit® pole and base MCS-BA-120-SET (with two integrated wheels) and/or MCS-BA-125-SET (two-wheel set available separately). Compatible with Securit® Battery Pack (available separately). Metal panel and magnets inside.

**FR** Porte-menu en acier inoxydable résistant aux intempéries, avec système de verrouillage. Vingt couleurs LED et 5 options de style de lumière avec 10 réglages d'intensité lumineuse. Prise d'alimentation, câble de cinq mètres et télécommande inclus. À fixer au mur (boulons inclus) ou à monter sur le pied et socle Securit® MCS-BA-120-SET (avec deux roues intégrées) et/ou MCS-BA-125-SET (jeu de deux roues disponible séparément). Compatible avec le Pack batterie Securit® (disponible séparément). Panneau métallique et aimants à l'intérieur.

**DE** Witterungsbeständiges Edelstahl-Display mit Schlosssystem. Mit 20 LED Farben, 5 Lichtstilooptionen und 10 Lichtintensitätseinstellungen. Inklusive Fernbedienung, sowie Netzstecker und 5 Meter langem Kabel. Sowohl zur Wandmontage (Montageset inklusive), als auch zur Montage auf einem der beiden Securit® Pfosten und Fuß MCS-BA-120-SET (mit integrierten Rollen) oder MCS-BA-125-SET (Rollen separat erhältlich) geeignet. Kompatibel mit Securit® Batterie (separat erhältlich). Magnetische Platte und Magnete inklusive.

**IT** Espositore a Led in acciaio inossidabile resistente agli agenti atmosferici, con sistema di chiusura a chiave. LED in 20 colori diversi, 5 opzioni d'illuminazione e 10 intensità di luce. Presa di alimentazione e cavo di 5 metri e telecomando inclusi. Compatibile con batteria a litio Securit® (non inclusa). Da montare a parete (kit di montaggio incluso) o su base e colonnina MCS-BA-120-SET (ruote incluse) o MCS-BA125-SET (ruote non incluse, acquistabili separatamente). Pannello metallico e magneti all'interno.

**ES** Expositor de LED en acero inoxidable resistente a los agentes atmosféricos, con sistema de cierre. Luces LED de 20 colores diferentes, 5 estilos y 10 intensidades de iluminación. Incluye cable de 5 metros con adaptador y control remoto. Compatible con la batería de Securit® (no incluida). Utilizable sobre pared (tornillos incluidos) o sobre set de poste y base MCS-BA-120-SET (ruedas incluidas) o set de poste y base MCS-BA-125-SET (las ruedas se venden por separado). Panel metálico e imanes en el interior.

**PT** Expositor em aço-inox com luzes LED e com fecho de chave. Luzes LED em 20 cores diferentes, 5 opções de estilo e 10 intensidade de iluminação. Inclui cabo de 5 metros com adaptador e controlo remoto. Compatível com a bateria de Securit® (no incluída). Para montagem na parede (pernas incluídos) ou no poste e base MCS-BA-120-SET (inclui 2 rodas) e/ou poste e base MSC-BA-125-SET (não inclui rodas, vendidas à parte). Painel metálico e ímãs dentro.

**NL** Weerbestendige roestvrijstalen kast met vergrendeling. Twintig LED-kleuren en 5 verlichtings opties met 10 lichtintensiteit-instellingen. Adapter, 5 meter kabel en afstandsbediening inbegrepen. Te monteren op de muur (inclusief bouten) of op Securit® paal en voet MCS-BA-120-SET (voet met twee wielen) en/of MCS-BA-125-SET (set met twee wielen beschikbaar, niet inbegrepen). Bruikbaar met Securit®-batterij (apart beschikbaar). Metalen paneel en magneten inbegrepen.

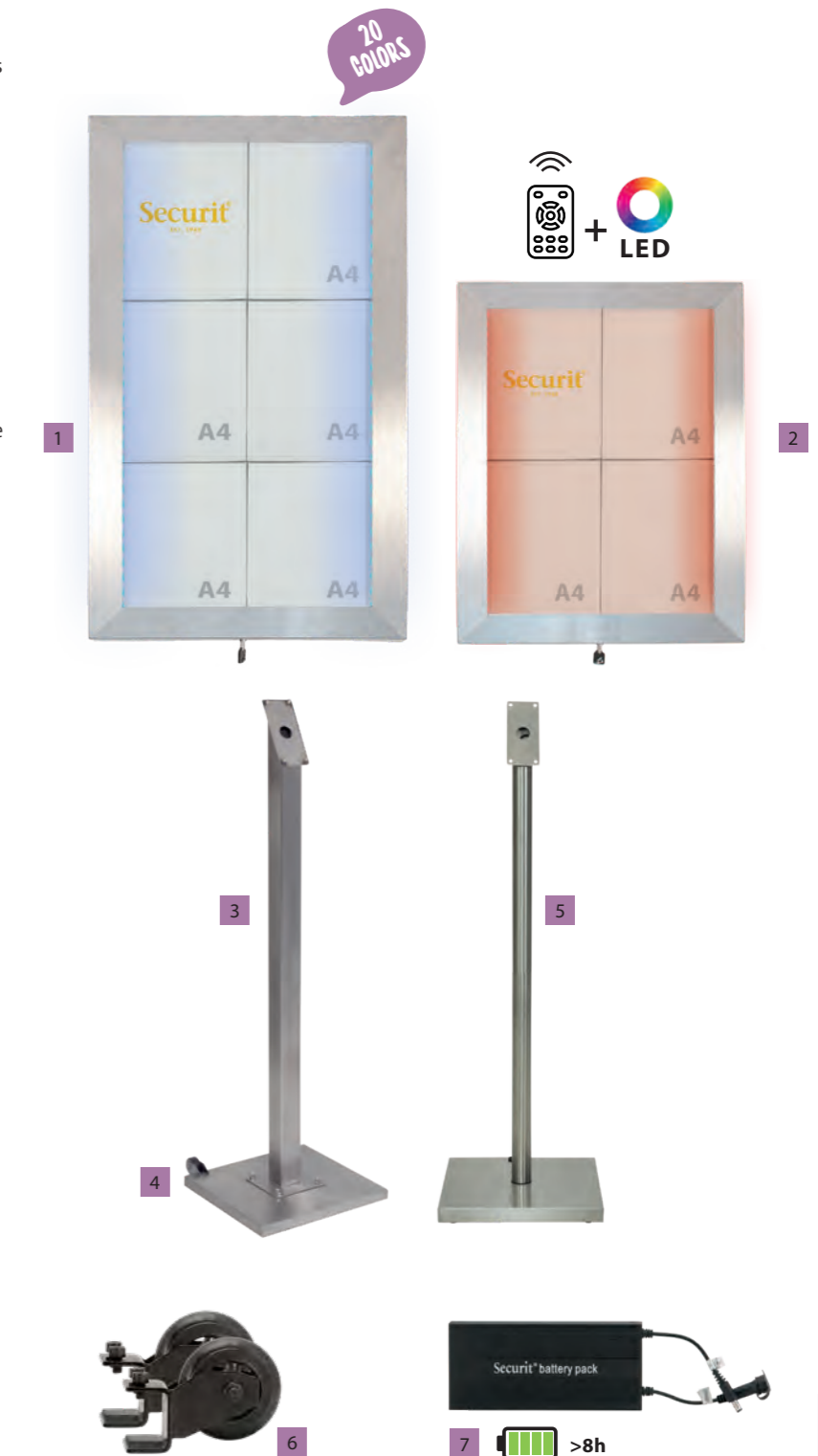

1	x	x
1	MCS-6A4-LSS	78x50,7x5cm 15,4kg
2	MCS-4A4-LSS	69,5x52,3x6,5cm 13,6kg
3	MCS-BA-120-G1	121x15x15cm 3,1kg
4	MCS-BA-G2	43,4x38,3x57cm 7,5kg
5	MCS-BA-125-SET	127x40x40cm 14,4kg

1	x	24
6	MCS-WH-2	5,5x12x9cm 0,8kg
1	x	24
7	MCS-BATT	16,5x7,5x1,3cm 0,3kg

Use of two batteries recommended (>12h).

**FR** Utilisation de 2 batteries recommandée (>12h).  
**DE** Verwendung von zwei Batterien empfohlen (>12h).  
**IT** Si consiglia l'utilizzo di due batterie (>12h).  
**ES** Se recomienda el uso de dos baterías (>12h).  
**PT** Recomendado o uso de 2 baterias (>12h).  
**NL** Gebruik van twee batterijen aanbevolen (>12h).

# COATED STEEL



All-weather resistant coated steel display case with lock system and hammertone finish. Extra bright white LED lights with multiple-function remote control (included). To be mounted on the wall (bolts included) or on Securit® pole and base of 95 cm / 135 cm. Additional wheel set available. Power plug and five-metre cable included. Compatible with Securit® Battery Pack (available separately). Metal panel and magnets inside.

**FR** Porte-menu en acier galvanisé résistant aux intempéries, avec système de verrouillage et finition martelée. Lumières LED blanches très brillantes avec télécommande multifonctions (incluse). A fixer au mur (boulons inclus) ou à monter sur le pied et socle Securit® de 95 cm / 135 cm. Jeu de roues supplémentaire disponible. Prise d'alimentation et câble de cinq mètres inclus. Compatible avec le Pack batterie Securit® (disponible séparément). Panneau métallique et aimants à l'intérieur.

**DE** Witterungsbeständiges Display aus beschichtetem Edelstahl mit Hammerschlaglackierung und Schlosssystem. Mit extra heller weißer LED-Beleuchtung inklusive Fernbedienung. Zur Wandmontage (Montageset inklusive) als auch zur Montage auf einem Securit® Standfuß von 95 cm / 135 cm geeignet. Passende Rollen separat erhältlich. Inklusive Netzstecker mit 5 Meter Kabel. Kompatibel mit Securit® Batterie (separat erhältlich). Magnetische Platte und Magnete inklusive.

**IT** Espositore in acciaio rivestito resistente agli agenti atmosferici, con sistema di chiusura a chiave. Luce a LED e telecomando multifunzione (incluso). Da montare a parete (kit di montaggio incluso) o su base e colonna Securit® da 95 cm / 135 cm d'altezza. Set di ruote disponibile separatamente. Presa di alimentazione e cavo di 5 metri inclusi. Compatibile con la batteria Securit® (non inclusa). Pannello metallico e magneti all'interno.

**ES** Expositor recubierto en acero resistente a las inclemencias del tiempo, con sistema de cierre. Incluye luces LED blancas extra brillantes y control remoto con múltiples funciones. Puede ser montado sobre pared (tornillos incluidos) o sobre set de poste y base de Securit®, de 95 cm o de 135 cm de largo. Set de ruedas se vende por separado. Incluye cable de 5 metros y enchufe. Compatible con la batería Securit® (no incluida). Panel metálico e imanes en el interior.

**PT** Expositor em aço revestido resistente a todas as intempéries com fecho de chave. Com luzes LED extra brilhantes com múltiplas funções e controlo remoto incluído. Adequado para aplicações de parede (parafusos incluídos) ou em poste e base Securit® (95 cm / 135 cm). Conjunto adicional de rodas disponível. Cabo de energia de 5 metros e controlo remoto incluídos. Compatível com pack de baterias Securit® (não incluído). Painel metálico e ímãs dentro.

**NL** Weerbestendig gecoate stalen kast met vergrendeling. Extra heldere LED-verlichting met multifunctionele afstandsbediening (inbegrepen). Te monteren op de muur (inclusief bouten) of op Securit® paal en voet van 95 cm / 135 cm. Set met wielen beschikbaar. Adapter en 5 meter kabel meegeleverd. Bruikbaar met Securit®-batterij (apart beschikbaar). Metalen paneel en magneten inbegrepen.



Image	Product Code	Dimensions (cm)	Weight (kg)
	MCS-3A4-CS	38,6x71,7x7,4	11,5
	MCS-6A4-CS	67,2x70,2x4,6	12,9
	MCS-BA-135-SETB	138x40x40	13,0
	MCS-BA-95-SETB	98x40x40	13,0

Image	Product Code	Dimensions (cm)	Weight (kg)
	MCS-WH-2	5,5x12x9	0,8
	MCS-BATT	16,5x7,5x1,3	0,3

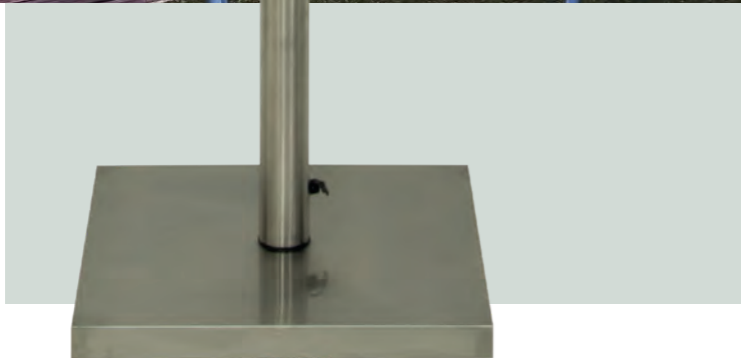

# CLASSIC

All-weather resistant wooden style or brushed stainless steel display case with lock system and white LED lights. To be mounted on wall (bolts included) or on Securit® pole and base MCS-BA-125-SET. Power plug and five-metre cable included. Compatible with Securit® Battery Pack (available separately).

**FR** Porte-menu résistant aux intempéries, effet bois ou en acier inoxydable brossé, avec système de verrouillage et lumières LED blanches. À fixer au mur (boulons inclus) ou à monter sur le pied et socle Securit® MCS-BA-125-SET. Prise d'alimentation et câble de cinq mètres inclus. Compatible avec le Pack batterie Securit® (disponible séparément).

**DE** Witterungsbeständiges Display mit Holzrahmen oder gebürstetem Edelstahlrahmen, Schlosssystem und weißer LED Beleuchtung. Zur Wandmontage (Montageset inklusive) als auch zur Montage auf dem Securit® Standfuß MCS-BA-125-SET geeignet. Passende Rollen separat erhältlich. Inklusive Netzstecker mit 5 Meter Kabel. Kompatibel mit Securit® Batterie (separat erhältlich).

**IT** Espositore in acciaio satinato o in legno con LED bianchi con sistema di chiusura a chiave. Resistente agli agenti atmosferici. Da montare a parete (kit di montaggio incluso) o sulla base e colonnina Securit® MCS-BA-125-SET. Presa di alimentazione, cavo di 5 metri e telecomando inclusi. Compatibile con la batteria Securit® (non inclusa).

**ES** Expositor de madera o acero inoxidable satinado, con sistema de cierre y luces LED blancas. Puede ser montado sobre pared (tornillos incluidos) o sobre poste y base Securit® modelo MCS-BA-125-SET. Incluye enchufe y cable de 5 metros. Es posible usarlo sin cable con la batería Securit® (no incluida).

**PT** Expositor em aço inoxidável escovado ou acabamento em madeira, com fecho de chave e LEDs brancas. Adequado para aplicações de parede (parafusos incluídos) ou em post e base Securit® MCS-BA-125-SET. Cabo de energia de 5 metros e controle remoto incluídos. Compatível com pack de baterias Securit® (não incluído).

**NL** Weerbestendige houtenstijf of geborsteld roestvrij stalen kast met vergrendeling en witte LED-verlichting. Te monteren op de muur (inclusief bouten) of op Securit® paal en basis MCS-BA-125-SET. Adapter en 5 meter kabel meegeleverd. Bruikbaar met Securit®-batterij (apart beschikbaar).



- 1 x x x
- 1 MCS-4A4-WLTE 69,7x53,3x5,5cm 8,8kg
- 2 MCS-4A4-WLDB 69,7x53,3x5,5cm 8,8kg
- 3 MCS-4A4-WLSS 66,7x50,5x5cm 8,0kg
- 4 MCS-BA-125-SET 127x40x40cm 14,4kg

- 1 x x 24
- 5 MCS-WH-2 5,5x12x9cm 0,8kg
- 1 x x 24
- 6 MCS-BATT 16,5x7,5x1,3cm 0,3kg





## RUSTIC

All-weather resistant coated fir wooden case with zinc roof, lock system and white LED lights. Available as wall-mounting set or complete with integrated self-standing pole and zinc base. Power plug and five-metre cable included. Compatible with Securit® Battery Pack (available separately).

**FR** Porte-menu en bois de sapin résistant aux intempéries, revêtu d'un toit en zinc, système de verrouillage et lumières LED blanches. Disponible en kit de montage mural ou complet avec pied autoportant intégré et socle en zinc. Prise de courant et câble de cinq mètres inclus. Compatible avec le pack batterie Securit® (disponible séparément).

**DE** Witterungsbeständiges Holzdisplay aus Tannenholz mit Zinkdach, Schlosssystem und weißer LED-Beleuchtung. Abschließbar. Erhältlich als Wandmontageset (Montageset inklusive) oder als komplett Set inklusive Holzpfosten und Zinkfuß. Passende Rollen separat erhältlich. Inklusive Netzstecker mit 5 Meter Kabel. Kompatibel mit Securit® Batterie (separat erhältlich).

**IT** Espositore stile rustico con LED bianchi e struttura in legno di abete rivestito. Resistente agli agenti atmosferici, con tetto in zinco e con sistema di chiusura a chiave. Da montare a parete (kit di montaggio incluso) o sulla base e colonnina. Ruote ordinabili a parte. Presa di alimentazione e cavo di 5 metri inclusi. Compatibile con la batteria Securit® (non inclusa).

**ES** Expositor de madera recubierta resistente a la intemperie con techo de zinc, sistema de cierre, luces LED blancas. Puede ser montado sobre la pared o sobre poste y base de zinc con ruedas. Las ruedas se venden por separado. Enchufe y cable de cinco metros incluidos. Compatible con la batería Securit® (no incluida).

**PT** Expositor de madeira revestida com teto em zinco resistente aos diferentes climas. Com fecho de chave e LEDs brancas. Pode ser montado na parede ou em poste e base de zinco com rodas (rodas não incluídas). Ficha de alimentação e cabo de cinco metros incluído. Compatível com pack de baterias Securit® (não incluído).

**NL** Weerbestendige gelakte houten kast met dak van zink, vergrendeling en witte LED-verlichting. Beschikbaar als wandmontageset of compleet met zelfdragende paal en voet van zink. Adapter en 5 meter kabel meegeleverd. Bruikbaar met Securit®-batterij (apart beschikbaar).



1 x x

1 MCS-4A4-WLR-SET 184,3x52,3x40,1cm 17,3kg

2 MCS-4A4-WLR 81,5x57,5x7,5cm 3,6kg

1 x x 24

3 MCS-WH-2 5,5x12x9cm 0,8kg

1 x x 24

4 MCS-BATT 16,5x7,5x1,3cm 0,3kg



## ACRYLIC

All-weather resistant acrylic case with white LED lights. To be used as table stand or on Securit® pole and base of 125 cm (MCS-BA-125-SET). Table stand, power plug and five-metre cable included.

**FR** Porte-menu en acrylique, résistant aux intempéries, avec des lumières LED blanches. À poser sur une table ou à monter sur le pied et socle Securit® de 125 cm (MCS-BA-125-SET). Support de table, fiche d'alimentation et câble de cinq mètres inclus.

**DE** Witterungsbeständiges Display aus schwarzem Acryl mit weißer LED-Beleuchtung und Tischständer. Auch zur Montage auf einen Securit® Standfuß (MCS-BA-125-SET) geeignet. Inklusive Netzstecker mit 5 Meter Kabel.

**IT** Espositore in acrilico con LED bianchi resistente agli agenti atmosferici. Da usare come supporto da tavolo o su base e colonnina Securit® di 125 cm (MCS-BA-125-SET). Supporto da tavolo, Presa di alimentazione e cavo di 5 metri inclusi.

**ES** Expositor de acrílico resistente a cualquier tipo de clima con luces LED blancas. Puede ser utilizado sobre mesas o sobre base y poste Securit®, de 125 cm de largo (MCS-BA-125-SET). Incluye soporte de mesa, enchufe y cable de 5 metros.

**PT** Expositor em acrílico resistente às intempéries com LEDs brancas. Pode ser utilizado em cima das mesas ou sobre base e poste Securit® (MCS-BA-125-SET). Base para mesa e cabo de energia de 5 metros incluídos.

**NL** Weerbestendige acryl behuizing met witte LED-verlichting. Te gebruiken als tafelstandaard of op Securit® paal en voet van 125 cm (MCS-BA-125-SET). Tafelstandaard, adapter en 5 meter kabel meegeleverd.



**Pole, base and wheels not included with display.**

**FR** Pied, socle et paire de roulettes non inclus avec le présentoir.

**DE** Pfosten, Fuß und Räder nicht im Lieferumfang des Displays enthalten.

**IT** Colonnina, base e ruote non incluse.

**ES** Poste, base y ruedas no incluidos.

**PT** Poste, base e rodas não incluídas.

**NL** Paal, voet en wielen zijn niet bij het display inbegrepen.



1 x 24  
3 MCS-WH-2 5,5x12x9cm 0,8kg

1 x x  
1 MCS-2A4-PA 49x53,5x4cm 3,5kg  
2 MCS-BA-125-SET 127x40x40cm 14,4kg



# GLASS STAR

All-weather resistant laminated wooden panel with a glass plate on the front and stainless steel style edges. To be mounted on wall (bolts included) or on Securit® pole and base MCS-BA-125-SET / MCS-BA-85-SET (not included). Available in two sizes. LED lamp system and two-wheel set available separately.

**FR** Porte-menu en bois laminé, résistant aux intempéries, avec une plaque de verre sur la face avant et des bords en acier inoxydable. À fixer au mur (boulons inclus) ou à associer au pied et socle Securit® MCS-BA-125-SET / MCS-BA-85-SET (non inclus). Disponible en deux tailles. Paires de roulettes et lampe LED disponibles séparément.

**DE** Witterungsbeständiges Display aus Hartholz mit Edelstahlumrandung und abgedichteter Glasplatte. Zur Wandmontage (Montageset inklusive) oder zur Montage auf einem Securit® Standfuß MCS-BA-125-SET / MCS-BA-85-SET (nicht im Lieferumfang enthalten) geeignet. In zwei verschiedenen Größen erhältlich. LED Lampe und Rollen separat erhältlich.

**IT** Display in legno laminato resistente agli agenti atmosferici con lastra di vetro frontale con bordi in acciaio inox. Da montare a muro (kit compreso) o su base e colonnina Securit® MCS-BA-125-SET / MCS-BA-85-SET (non inclusi). Disponibile in due misure. Ruote per la base e lampada a LED acquistabili separatamente.

**ES** Expositor de madera laminada resistente a la intemperie, con placa de cristal frontal y bordes de acero inoxidable. Para montar sobre pared (tornillos incluidos) o sobre los sets de base y poste Securit® MCS-BA-125-SET o MCS-BA-85-SET (no incluidos). Disponible en dos tamaños. Las ruedas para la base y la lámpara LED se venden por separado.

**PT** Expositor em madeira, com placa frontal em vidro e moldura em aço inoxidável. Com sistema de fixação adequado a parede (parafusos incluídos) ou em base e poste Securit® MCS-BA-125-SET / MCS-BA-85-SET (não incluídos). Disponível em dois tamanhos. Lâmpada LED e rodas disponível (não incluído).

**NL** Weersbestendig gelamineerd houten paneel met glasplaat aan de voorkant en randen in stijl van roestvrij staal. Te monteren op de muur (inclusief bouten) of op Securit® paal en voet MCS-BA-125-SET / MCS-BA-85-SET (niet inbegrepen). Verkrijgbaar in twee maten. LED-lamp systeem en wielen apart verkrijgbaar.

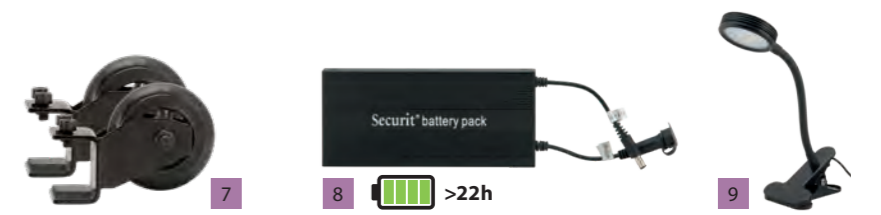

1	x	x	
1	MCS-4A4-WAL	74,4x57x3cm	8,9kg
2	MCS-4A4-OAK	74,4x57x3cm	8,9kg
3	MCS-A4-WAL	36,8x28x3cm	1,9kg
4	MCS-A4-OAK	36,8x28x3cm	1,9kg
5	MCS-BA-125-SET	127x40x40cm	14,4kg
6	MCS-BA-85-SET	90x27x27cm	6,6kg

1	x	24	
7	MCS-WH-2	5,5x12x9cm	0,8kg
1	x	24	
8	MCS-BATT	16,5x7,5x1,3cm	0,3kg
1	x	6	
9	LP-BL-1	27x7,5x11cm	0,4kg



## MENU STAND

Stainless steel stand with laminated wooden panel, integrated elastic bands and four knobs to hold a menu. Wheels and LED lamp system available separately.

**FR** Présentoir en acier inoxydable avec panneau de bois laminé, bandes élastiques intégrées et quatre supports pour maintenir un menu. Paire de roulettes et lampe LED disponibles en option (non incluses).

**DE** Laminiertes Holzdisplay mit integrierten elastischen Bändern und Knöpfen die die Speisekarte halten. Edelstahlstandfuß inkludiert. Rollen und LED-Lampe separat erhältlich.

**IT** Leggio porta menù in legno laminato, con quattro perni in metallo per sostenere il menù e elastici inclusi. Ruote per la base e lampada a LED ordinabili a parte.

**ES** Atril porta menú realizado en madera con cuatro perillas y bandas elásticas integradas. Las ruedas para la base y la lámpara LED se venden por separado.

**PT** Display com base em aço inoxidável e suporte para menu em madeira. Quatro pins para suporte dos menu e elásticos incluídos. Rodas para base e lâmpada de LED disponível (não incluído).

**NL** Roestvrijstalen paal met gelamineerd houten paneel, elastische banden en vier knoppen om een menukaart te plaatsen. Wielen en LED-lamp systeem afzonderlijk verkrijgbaar.

- 1 x x
- 1 MCS-115-TE 113,7x54,2x36,7cm 11,9kg
- 1 x 24
- 2 MCS-WH-2 5,5x12x9cm 0,8kg
- 1 x 24
- 3 MCS-BATT 16,5x7,5x1,3cm 0,3kg
- 1 x 6
- 4 LP-BL-1 27x7,5x11cm 0,4kg



# DISPLAY ACCESSORIES

## Pole + Base

- Stainless Steel
- Classic
- Acrylic
- Glass Star

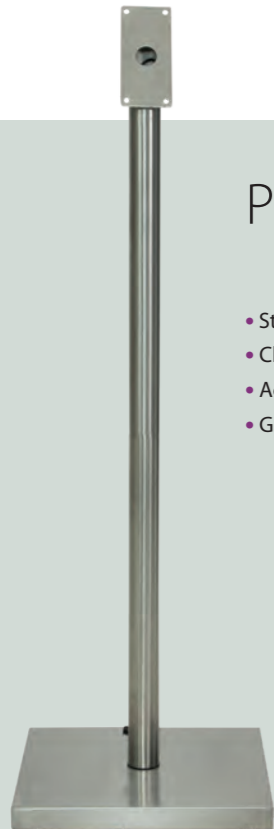

1 x 1 x 1  
MCS-BA-125-SET 127x40x40cm 14,4kg

Stainless steel supporting pole and base with floor-protection: pole in two pieces to allow display case positioning. Additional two-wheel set available (not included). Waterproof power plug and five-metre cable included.

**FR** Pied et socle de support en acier inoxydable, avec protection du sol: pied en deux pièces, permettant le positionnement du présentoir. Paire de roulettes supplémentaire disponible (non incluse). Prise d'alimentation électrique étanche et câble de 5 mètres inclus.

**DE** Pfosten und Fuß (inkl. Bodenschutz) aus Edelstahl; zweiteiliger Pfosten, so dass sich das Display besser positionieren lässt. Passende Rollen separat erhältlich. Inklusive wasserfestem, 5 Meter langem Kabel mit Netzstecker.

**IT** Colonnina e base anti-graffio in acciaio inossidabile. Colonnina in due parti permette il facile posizionamento dell'espositore. Set addizionale di due ruote (non incluso). Spina di alimentazione impermeabile e cavo di cinque metri incluso.

**ES** Poste y base anti-rayones de acero inoxidable. Poste en dos piezas para facilitar el posicionamiento del expositor. Set adicional de 2 ruedas disponible (no incluido). Enchufe y cable de 5 metros incluidos.

**PT** Poste e base com protecção do chão em aço inoxidável. Poste em duas peças para permitir o posicionamento do expositor. Set adicional de duas rodas disponível (não incluído). Ficha elétrica e cabo de electricidade com 5 metros incluído.

**NL** Roestvrijstalen paal en voet met vloer bescherming: paal in twee stukken om de behuizing van de display te positioneren. Set met twee wielen beschikbaar (niet inbegrepen). Waterdichte stekker en vijf meter kabel meegeleverd.

## Wheels

- Stainless Steel
- Coated Steel
- Classic
- Black Star
- Rustic
- Acrylic
- Glass Star
- Menu Stand



1 x 24  
MCS-WH-2 5,5x12x9cm 0,8kg

Silicone wheels with black powder-coated stainless steel frame. Suitable for all types of ground surfaces.

**FR** Roulettes en silicone, support avec structure en acier galvanisé noir. Convient pour tous les types de surfaces au sol.

**DE** Rollen aus Silikon mit schwarzen pulverbeschichtetem Edelstahlrahmen. Geeignet für alle Untergründe.

**IT** Ruote in silicone con struttura in acciaio inox verniciato a polvere nera. Ideali per tutti i tipi di superfici.

**ES** Ruedas de silicona, con estructura de soporte de acero inoxidable con recubrimiento de polvo negro. Ideal para cualquier tipo de superficie.

**PT** Rodas de silicone com moldura de aço revestida a pó preto. Adequadas para todos os tipos de superfícies moidas.

**NL** Siliconen wielen, gepoedercoat roestvrijstalen frame. Geschikt voor alle soorten grondoppervlakken.

## LED Lamp

- Glass Star
- Menu Stand
- Pavement Board



1 1x

2 2x

1 x 6  
1 LP-BL-1  
27x7,5x11cm 0,4kg  
1 x 6  
2 LP-BL-2  
27x7,5x11cm 0,8kg

All-weather resistant LED lamp designed to illuminate any pavement chalkboard and/or information display. Optionally powered by the waterproof Securit® Battery Pack with advanced lithium ion technology. Five-metre electrical power cable included.

**FR** Lampe LED, résistante aux intempéries, conçue pour illuminer les panneaux trottoir et/ou des présentoirs menus. \*Peut être utilisée avec le Pack Batterie étanche Securit®, doté d'une technologie avancée au lithium-ion. Câble d'alimentation de 5 mètres inclus.

**DE** Witterungsbeständiges LED Lampe zur Beleuchtung von allen handelsüblichen Gehwegtafeln und/oder Informationsdisplays. Alternativ betrieben mit einer wasserdichten Securit® Batterie (separat erhältlich). 5 Meter Netzkabel inklusive.

**IT** Lampada a LED resistente a tutte le condizioni atmosferiche, progettata per illuminare qualsiasi lavagna da terra e/o display informativo. Utilizzabile anche con la batteria ricaricabile impermeabile Securit® con tecnologia avanzata agli ioni di litio. Presa di alimentazione elettrica di cinque metri inclusa.

**ES** Lámpara LED resistente a la intemperie diseñada para iluminar cualquier pizarra caballete y expositor. Se puede alimentar con la batería Securit® resistente al agua con tecnología avanzada de iones de litio. Se incluye un cable de alimentación eléctrica de cinco metros.

**PT** Lâmpada LED resistente às intempéries concebida para iluminar qualquer quadro de pavimento e expositor. Pode ser alimentado pela bateria Securit® à prova de água com tecnologia avançada de iões de lítio. Está incluído um cabo de alimentação de cinco metros.

**NL** Weersbestendige LED-lamp om elk stoepbord en/of informatie display te verlichten. Inclusief 5 meter stroomkabel. \*Bruikbaar met waterdichte Securit® batterij, voorzien van geavanceerde lithium-ion-technologie.

## Battery

- Stainless Steel
- Coated Steel
- Classic
- Black Star
- Black Star XXL
- Rustic
- LED Lamp



1 x 24  
MCS-BATT 16,5x7,5x1,3cm 0,3kg

Advanced lithium-ion technology, protected against water and penetration by pointed objects (IP44). Recharges in four hours and lasts for 8-36 hours (depending on usage and information display model). Input: 12V ~ 1,5A | Output: 12V ~ 1,8A | Capacity: 48 Wh.

**FR** Technologie Lithium-ion avancée, résistant à l'eau et à la pénétration d'objets pointus (IP44). Rechargée en 4 heures et autonomie de 8 à 36 heures (dépendant de l'utilisation et du modèle de présentoir choisi). Entrée : 12V ~ 1,5A | Sortie: 12V ~ 1,8A | Puissance: 48 Wh. **DE** Fortgeschrittene Lithium-Ionen-Technologie. Wasserbeständig und vor Stößen und Beschädigung mit scharfen Gegenständen geschützt (IP44). Ladezeit: 4 Stunden. Nutzungsdauer 8-36 Stunden (je nach Gebrauch und genutztem Modell) | Input: 12V ~ 1,5A | Output: 12V ~ 1,8A | Kapazität: 48 Wh. **IT** Batteria agli ioni di litio con custodia protettiva per evitare il danneggiamento se a contatto con acqua e/o oggetti appuntiti (IP44). Si ricarica in solo 4 ore e assicura da 8 a 12 ore di luce (dipende dall'utilizzo e dal modello di espositore). Ingresso: 12V ~ 1,5A | Uscita: 12V ~ 1,8A | Capacità: 48 Wh. **ES** Batería de iones de litio, protegida contra el agua y objetos punzantes (IP44). Demora dos horas en cargarse y permite de 8 a 12 horas de energía (dependiendo de su uso y del modelo de expositor). Entrada: 12V ~ 1,5A | Salida: 12V ~ 1,8A | Capacidad: 48 Wh. **PT** Bateria com tecnologia avançada de iões de lítio, protegida contra a água e penetração por objetos pontiagudos (IP44). Recarrega em duas horas e dura de 8 a 12 horas (dependendo do uso e do modelo de informação de expositor). Entrada: 12v ~ 1,5A | Saída: 12v ~ 1,8A | Capacidade: 48 Wh. **NL** Geavanceerde lithium-ion-technologie, beschermd tegen water en penetratie van puntige objecten (IP44). Laadt op in vier uur met een gebruikscapaciteit van 8-36 uur (afhankelijk van gebruik en model informatie display). Input: 12V ~ 1,5A | Output: 12V ~ 1,8A | Capaciteit: 48 Wh.



# BARRIER SYSTEMS & SMOKER POLES

- FR** POTEaux D'ACCUEIL ET CENDRIERS
- DE** ABSPRERRSYSTEME & ASCHENBECHER SÄULEN
- IT** COLONNE SEGNAPERCORSO & POSACENERI
- ES** POSTES DE ACOGIDA & CENICEROS
- PT** POSTES SEPARADORES & CINZEIROS
- NL** AFZETPALEN & ASBAKKEN



# CLASSIC

All-weather resistant polished stainless steel barrier system with chrome or gold finish and four-way rope connection top ring. Screw top to add accessory sign frame. Antiscratch, floor-protecting, reinforced base. Wall hook and ropes with matching chrome or gold finish available separately.

**FR** Poteau d'accueil en acier inoxydable poli, résistant aux intempéries, finition chrome ou doré. Bague d'accroche avec 4 encoches pour l'attache d'une corde. Tête amovible permettant d'insérer un porte-affiche sur le dessus. Socle renforcé, anti-rayures et avec protection du sol. Crochet mural et cordes avec finition chromée ou dorée assortie, disponibles séparément.

**DE** Witterungsbeständiges Absperrsystem aus poliertem Edelstahl mit Chrom- oder Gold-Finish und 4-Wege Verbindungsring für Absperrkordeln. Inklusive nicht kratzendem, bodenschonendem, verstärktem Fuß. Wandhaken und Absperrkordel mit passendem Chrom- oder Gold-Finish separat erhältlich. Ein zusätzlicher Schilderrahmen kann auf dem Pfosten angebracht werden.

**IT** Colonnina segnapercorso in acciaio inossidabile lucido, con finitura cromata o dorata, resistente agli agenti atmosferici, con anello nella parte superiore per la connessione di quattro cordoni. Parte superiore svitabile per aggiungere un porta avvisi. Base rinforzata antigraffio per la protezione del pavimento. Gancio a muro e cordoni con finitura cromata o dorata disponibili separatamente.

**ES** Poste de acero inoxidable pulido cromado o dorado, resistente a la intemperie, con anillo en la parte superior para conexión de cuatro cuerdas. La tapa se puede desatornillar para agregar carteles. Base reforzada anti-rayones para protección del piso. Gancho de pared y cuerdas con acabado cromado o dorado a juego disponibles por separado.

**PT** Barreira de aço inoxidável polido cromada ou dourada, resistente a todos os climas, com anel no topo para ligação de quatro cordas. Com tampa de rosca que permite adicionar acessórios como sinais. Base reforçada anti-arranhões e com protecção do chão. Gancho de parede cromado ou dourado e cordas disponíveis separadamente.

**NL** Weersbestendig gepolijst roestvrijstalen afzetpaal met gouden afwerking, ronde kop en bovenring met vier-weg verbinding voor koord Schroefdop om informatiebord toe te voegen. Anti-kras, vloerbeschermende verstevigde voet. Koorden met bijpassende goud afgewerkte clips zijn los verkrijgbaar.



1	x	5	
1	RS-CLRP-CHWT	152x4x4cm	0,9kg
2	RS-CLRP-CHBR	152x4x4cm	0,9kg
3	RS-CLRP-CHBL	152x4x4cm	0,9kg
4	RS-CLRP-CHBU	152x4x4cm	0,9kg
5	RS-CLRP-CHRD	152x4x4cm	0,9kg
6	RS-CLWH-CH	5x3,8x4cm	0,1kg
7	RS-SIGN-A4-PC	34,3x21,5x2,1cm	0,8kg

1	x	5	
10	RS-CLRP-GOWT	152x4x4cm	0,9kg
11	RS-CLRP-GOBR	152x4x4cm	0,9kg
12	RS-CLRP-GOBL	152x4x4cm	0,9kg
13	RS-CLRP-GOBU	152x4x4cm	0,9kg
14	RS-CLRP-GORD	152x4x4cm	0,9kg
15	RS-CLWH-GO	5x3,8x4cm	0,1kg
16	RS-SIGN-A4-PG	34,3x21,5x2,1cm	0,8kg

1	x	x	
8	RS-CL-CH-B1	87,5x9,5x9,5cm	1,2kg
9	RS-CL-CH-B2	10x31x31cm	9,6kg
8+9	RS-CL-CH-SET	95x31x31cm	10,8kg
17	RS-CL-GO-A1	87,5x9,5x9,5cm	1,2kg
18	RS-CL-GO-A2	10x31x31cm	9,6kg
17+18	RS-CL-GO-SET	95x31x31cm	10,8kg

SKU/item Inner Master



NEW

## SET OF 2 BUDGET RETRACTABLE BLACK

All-weather resistant, coated black stainless steel, anti-scratch, floor-protecting reinforced base, pole has four connection points. 200 cm retractable nylon band with lock included. Sold as a set of two. An additional sign frame can be attached to the barrier system.

**FR** Poteaux d'accueil résistant aux intempéries, en acier galvanisé inoxydable noir, avec socle renforcé, antirayures et protection du sol. Possédant 4 points de connexion pour lier les poteaux entre eux. Bande rétractable en nylon de 200 cm. Vendu en lot de 2.

**DE** Witterungsbeständiges Absperrsystem aus schwarz beschichtetem Edelstahl. Inklusive nicht kratzendem, bodenschonendem, verstärktem Fuß und Absperrpfosten mit vier Verbindungspunkten. 200 cm langes Nylon Absperrband inklusive Schloss. Nur im 2er Set erhältlich. Ein zusätzlicher Schilderrahmen kann auf dem Pfosten angebracht werden.

**IT** Colonna segnapercorso in acciaio inossidabile rivestito in nero, resistente agli agenti atmosferici, con base antigraffio per la protezione del pavimento e quattro punti di connessione. Nastro retrattile di 200 cm in nylon. Venduto come set di due.

**ES** Poste de acero inoxidable revestido en negro, resistente a la intemperie, base reforzada anti-rayones para protección del piso. El poste tiene 4 puntos para la conexión de hasta cuatro cintas. Incluye cinta de nylon retráctil de 200 cm. Se vende como set de dos.

**PT** Poste em aço inoxidável revestido em preto, resistente a todos os climas, com base anti-riscos reforçada para proteção de chão. O poste tem 4 pontos para a conexão de até quatro fitas. Fita retrátil em nylon incluída (200 cm). Vendido em conjunto de dois.

**NL** Weerbestendig, geborsteld of gecoat zwart roestvrij staal, anti-kras, vloer beschermende verstevigde voet, schroefdop om informatiebord toe te voegen, paal heeft vier verbindingpunten. Inclusief uittrekbare nylon band van 200 cm. Verkocht als een set van twee.

1 x 5

1 RS-SIGN-A4-BL 47x24,2x6,8cm 0,9kg

1 x 1

2 RS-RT-LW-BL 93x33x33cm 16,8kg





## SET OF 2 BUDGET RETRACTABLE

All-weather resistant, brushed stainless steel with chrome finish, anti-scratch floor-protecting reinforced base, pole has four connection points. 200 cm retractable nylon band with lock included. Sold as a set of two. An additional sign frame can be attached to the barrier system.

**FR** Poteau d'accueil en acier inoxydable brossé, résistant aux intempéries, finition chromée. Socle renforcé par une protection antirayure et avec protection du sol. Pied disposant de quatre points de connexion. Sangle en nylon rétractable de 2 mètres, avec verrou inclus. Vendu par lot de 2.

**DE** Witterungsbeständiges Absperssystem aus gebürstetem Edelstahl mit Chrome-Finish. Inklusive nicht kratzendem, bodenschonendem, verstärktem Fuß und Absperropfsten mit vier Verbindungspunkten. 200 cm langes Nylon Abspermband inklusive Schloss. Nur im 2er Set erhältlich. Ein zusätzlicher Schilderrahmen kann auf dem Pfosten angebracht werden.

**IT** Set di 2 colonnine segnapercorso in acciaio inossidabile spazzolato con finitura cromata, base rinforzata antigraffio per la protezione del pavimento e resistenti agli agenti atmosferici. Colonnina con nastro in nylon retrattile di due metri con chiusura inclusa e con quattro punti di connessione.

**ES** Pack de 2 postes de acero inoxidable cepillado con acabado cromado, base reforzada anti-rayones y a la intemperie. Poste con cinta de nylon retráctil de dos metros con cierre incluido y cuatro puntos de conexión.

**PT** Set de 2 postes em aço inoxidável escovado com acabamento cromado, base reforçada resistente aos riscos e às intempéries. Poste com fita de nylon retráctil de dois metros com fechadura incluída com quatro vias.

**NL** Weerbestendig, geborsteld roestvrij staal met chroom afwerking, anti-kras, vloer beschermende versterkte voet, paal heeft vier-weg verbindingspunten. Inclusief intrekbare nylon riem van twee meter met slot. Verkocht als een set van twee.

- 1 x 1  
**1 RS-RT-LW-CH** 93x33x33cm 16,8kg  
 1 x 5  
**2 RS-SIGN-A4-PS** 45,3x21,8x6,7cm 0,9kg

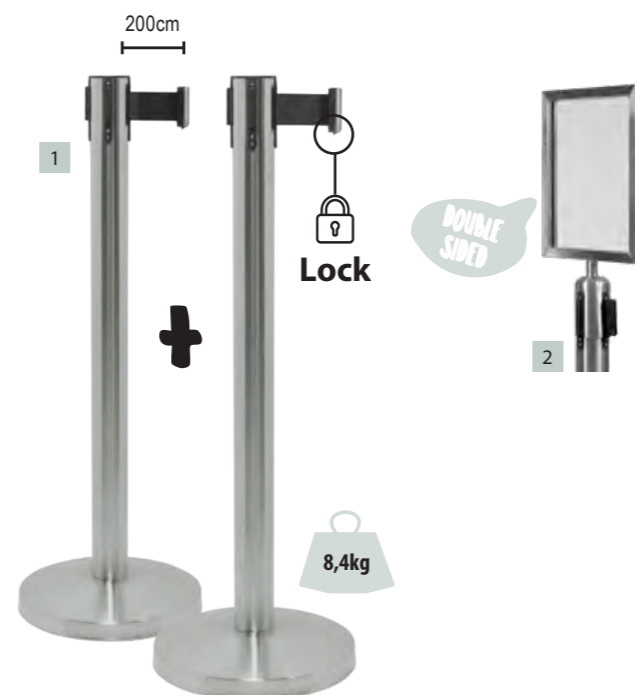

## SET OF 2 BUDGET

All-weather resistant polished stainless steel with chrome finish, four-way rope connection top ring, anti-scratch floorprotecting reinforced lightweight base. Sold as a set of two.

**FR** Poteau d'accueil poli, en acier inoxydable, résistant aux intempéries, finition chromée. Bague d'accroche avec 4 encoches pour l'attache d'une corde. Socle léger et renforcé par une protection anti-rayures et avec protection du sol. Vendu par lot de 2.

**DE** Witterungsbeständiges Absperssystem aus poliertem Edelstahl mit Chrome-Finish und 4-Wege Verbindungsring für Absperrkordeln. Inklusive nicht kratzendem, bodenschonendem, leichtem Fuß. Nur im 2er-Set erhältlich.

**IT** Set di due colonnine segnapercorso in acciaio inossidabile lucido con finitura cromata resistente agli agenti atmosferici. La colonnina ha un anello di collegamento per agganciare quattro cordoni. Base resistente ma leggera, rinforzata e anti-graffio.

**ES** Pack de dos postes de acero pulido inoxidable resistente a la intemperie con acabado cromado y anillo en su parte superior para conexión de 4 cuerdas. Base ligera reforzada anti-rayones para protección del piso.

**PT** Set de dois postes em aço inoxidável com acabamento cromado resistente a intempéries, anel superior de conexão para 4 cordas. Base leve reforço anti-riscos para proteger o chão.

**NL** Weersbestendig gepolijst roestvrij staal met chroom afwerking, bovenring voor vier-weg verbinding voor touw, anti-kras, vloerbeschermende versterkte lichtgewicht voet. Verkocht als een set van twee.

- 1 x 1  
**1 RS-LW-CH** 100x33x33cm 15,8kg

- 1 x 5  
**2 RS-CLRP-CHWT** 152x4x4cm 0,9kg  
**3 RS-CLRP-CHBR** 152x4x4cm 0,9kg  
**4 RS-CLRP-CHBL** 152x4x4cm 0,9kg  
**5 RS-CLRP-CHBU** 152x4x4cm 0,9kg  
**6 RS-CLRP-CHRD** 152x4x4cm 0,9kg  
**7 RS-CLWH-CH** 5x3,8x4cm 0,1kg





## RETRACTABLE

All-weather resistant, brushed stainless steel, anti-scratch floor-protecting reinforced base, pole has four-way connection points. 205 cm retractable nylon band and wall mounting clip included. An additional sign frame can be attached to the barrier system.

**FR** Poteaux d'accueil en acier inoxydable brossé, résistants aux intempéries. Socle renforcé par une protection anti-rayures et avec protection du sol. Possédant 4 encoches pour lier les poteaux entre eux. Bande rétractable en nylon, de 205 cm et clip de fixation murale inclus. Un porte-affiche supplémentaire peut être fixé sur le poteau.

**DE** Witterungsbeständiges Absperresystem aus gebürstetem Edelstahl. Inklusive nicht kratzendem, bodenschonendem, verstärktem Fuß und Absperropfosten mit vier Verbindungspunkten. 205 cm langes Nylon Abspermband und Wandbefestigungsclip inklusive. Ein zusätzlicher Schilderrahmen kann auf dem Pfosten angebracht werden.

**IT** Colonnina segnapercorso in acciaio inossidabile spazzolato con finitura cromata, base rinforzata antigraffio per la protezione del pavimento e resistente agli agenti atmosferici. Colonnina con nastro in nylon retrattile di 2,05 metri, con quattro punti di connessione e clip di montaggio a parete inclusi. Parte superiore della colonnina svitabile per aggiungere un porta avvisi.

**ES** Poste de acero de acero inoxidable cepillado con acabado cromado, base reforzada anti-rayones y a la intemperie. Poste con cinta de nylon retráctil de 2,05 metros y clip de montaje a pared y cuatro puntos de conexión. La tapa superior se puede desatornillar para agregar carteles.

**PT** Poste em aço inoxidável escovado com acabamento cromado, base reforçada resistente aos riscos e às intempéries. Poste com fita de nylon retráctil de 2,05 metros com quatro vias e clip de montagem na parede. Com tampa de rosca que permite adicionar acessórios tais como sinais.

**NL** Weerbestendig, geborsteld roestvrij staal, anti-kras, vloer beschermende versterkte voet, schroefdop om accessoire bord toe te voegen, paal heeft vier-weg verbindingspunten. Inclusief intrekbare nylon band van 2,05 meter en wand bevestigingsclip.

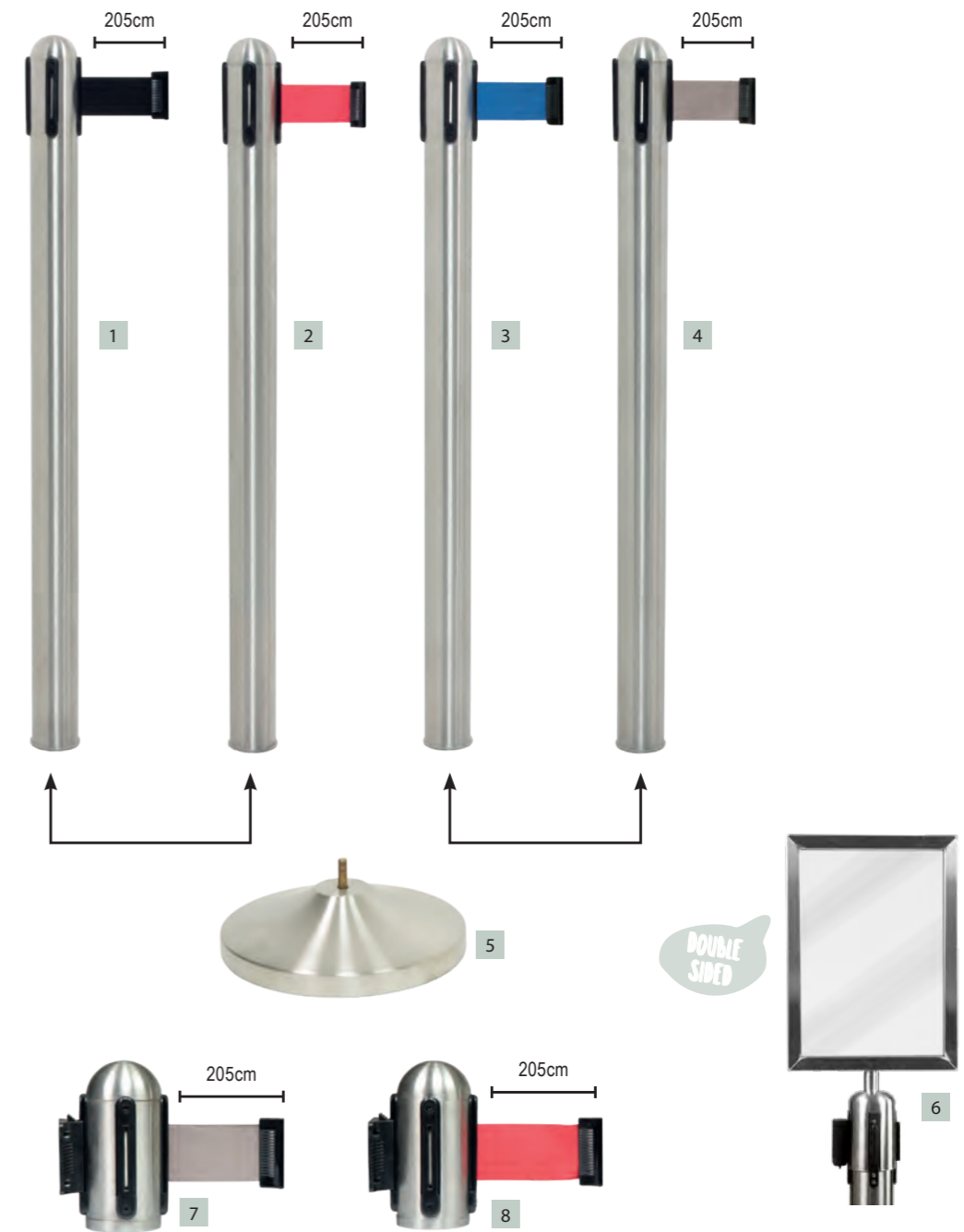

1	x	x	
1	RS-RT-RVS-BL-C4	96x7x7cm	1,5kg
2	RS-RT-RVS-RD-C1	96x7x7cm	1,5kg
3	RS-RT-RVS-BU-C5	96x7x7cm	1,5kg
4	RS-RT-RVS-GY-C2	96x7x7cm	1,5kg
5	RS-RT-RVS-C3	8,8x31x31cm	9,5kg
1 + 5	RS-RT-RVS-BL-SET	101x31x31cm	11kg
2 + 5	RS-RT-RVS-RD-SET	101x31x31cm	11kg
4 + 5	RS-RT-RVS-GY-SET	101x31x31cm	11kg

1	x	5	
6	RS-SIGN-A4-PS	45,3x21,8x6,7cm	0,9kg
7	RS-RTWM-RVS-GY	14,3x7,5x7,5cm	0,4kg
8	RS-RTWM-RVS-RD	14,3x7,5x7,5cm	0,4kg



## RETRACTABLE BLACK

All-weather resistant, coated black stainless steel, anti-scratch floor protecting reinforced base, pole has four-way connection points. 205 cm retractable nylon band and wall mounting clip included. An additional sign frame can be attached to the barrier system.

**FR** Poteaux d'accueil résistant aux intempéries, en acier galvanisé inoxydable noir, avec socle renforcé par une protection anti-rayures et avec protection du sol. Possédant 4 encoches pour lier les poteaux entre eux. Bande rétractable en nylon, de 205 cm et clip de fixation murale inclus. Un porte-affiche supplémentaire peut être fixé sur le poteau.

**DE** Witterungsbeständiges Absperrsystem aus schwarz beschichtetem Edelstahl. Inklusive nicht kratzendem, bodenschonendem, verstärktem Fuß und

Absperrpfosten mit vier Verbindungspunkten. 205 cm langes Nylon Absperrband und Wandbefestigungsclip inklusive. Ein zusätzlicher Schilderrahmen kann auf dem Pfosten angebracht werden.

**IT** Colonnina segnapercorso in acciaio inossidabile rivestito in nero, resistente agli agenti atmosferici, con base antigraffio per la protezione del pavimento. Nastro in nylon retrattile di 2,05 metri con quattro punti di connessione e clip di montaggio a parete inclusi. Parte superiore della colonnina svitabile per aggiungere un porta avvisi.

**ES** Poste de acero inoxidable revestido en negro, resistente a la intemperie, con base reforzada anti-rayones para protección del piso. El poste tiene 4 puntos para la conexión de hasta cuatro cintas. Incluye cinta de nylon retráctil de 205 cm y clip de montaje a pared. La tapa superior se puede desatornillar para agregar carteles.

**PT** Poste em aço inoxidável revestido em preto, com base anti-riscos reforçada para proteção de chão. Poste com fita de nylon retráctil de 2,05 metros com quatro vias e clip de montagem em na parede. Com tampa de rosca que permite adicionar acessórios tais como sinais.

**NL** Weerbestendig, gecoat zwart roestvrij staal, anti-kras, vloer beschermende versterkte voet, schroefdop om accessoire bord toe te voegen, paal heeft vier-weg verbindingpunten. Inclusief intrekbare nylon band van 2,05 meter en wand bevestigingsclip.

- |   |               |               |       |
|---|---------------|---------------|-------|
| 1 | x             | x             |       |
| 1 | RS-RT-BL-C8   | 95x6,4x6,4cm  | 1,7kg |
| 2 | RS-RT-BL-C9   | 8,8x31x31cm   | 9,5kg |
| 1 | x             | 5             |       |
| 3 | RS-SIGN-A4-BL | 47x24,2x6,8cm | 0,9kg |



## CARPETS

All-weather resistant robust anti-slip carpets of 200 cm x 90 cm. Available in red and black.

**FR** Tapis résistant aux intempéries, robuste, antidérapant, de 200 cm sur 90 cm. Disponible en rouge et noir.

**DE** Witterungsbeständige, robuste und rutschfeste Teppiche von 200 cm x 90 cm. Erhältlich in rot und schwarz.

**IT** Tappeto di 200 x 90 cm in poliestere robusto e antiscivolo. Resistente alle condizioni climatiche. Disponibile sia in nero che in rosso.

**ES** Alfombra de 200 x 90 cm en poliéster robusto y antideslizante. Resistente a la intemperie. Disponible en rojo y negro.

**PT** Carpete antiderrapantes resistentes a todas as intempéries de 200 cm por 90 cm. Disponível em vermelho e preto.

**NL** Weersbestendige robuuste anti-slip tapijten van 200 cm bij 90 cm. Verkrijgbaar in rood en zwart.

- |   |           |              |       |
|---|-----------|--------------|-------|
| 1 | x         | 3            |       |
| 4 | RS-200-BL | 200x90x0,7cm | 3,9kg |
| 5 | RS-200-RD | 200x90x0,7cm | 3,9kg |

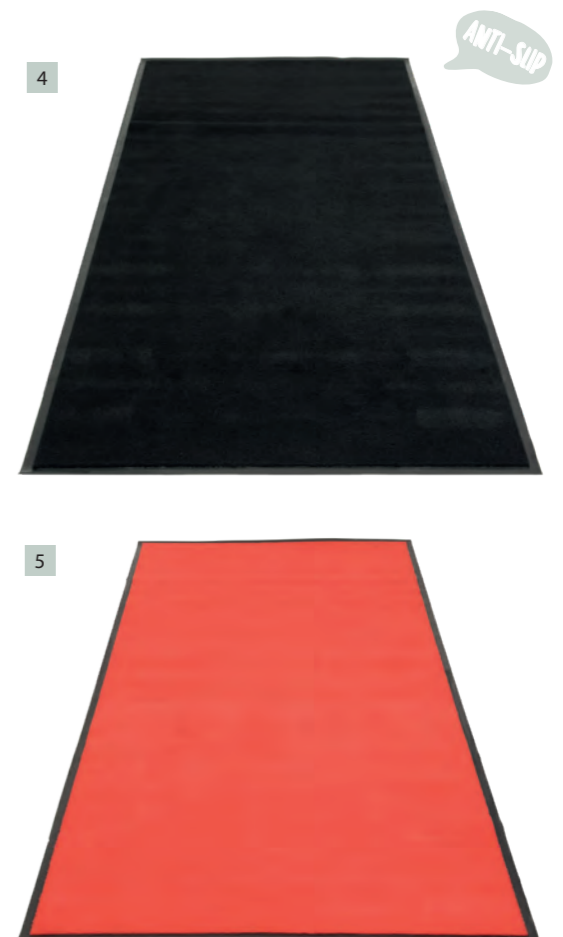

# SMOKER POLES

All-weather resistant coated gold, black and stainless steel smoker poles. Easy to empty with removable cap. Free-standing with floor-protection (can hold up to 3.500 cigarettes), or wall-mounting models (can hold up to 1.200 cigarettes).

**FR** Cendriers résistant aux intempéries, disponibles en inox poli, acier galvanisé noir ou finition dorée. Facile à nettoyer grâce à un embout amovible. Disponibles sur pied avec protection du sol (pouvant contenir jusqu'à 3 500 cigarettes), ou en montage mural (pouvant contenir jusqu'à 1 200 cigarettes).

**DE** Witterungsbeständige Aschenbecher erhältlich in Edelstahl, Goldoptik und Schwarz. Einfach zu

reinigen aufgrund des abnehmbaren Deckels. Freistehender Aschenbecher mit Bodenschutz (bis zu 3.500 Zigaretten) oder Wandaschenbecher (bis zu 1.200 Zigaretten).

**IT** Posacenieri in acciaio inox spazzolato o rivestito in color oro e resistente agli agenti atmosferici. Facili da svuotare grazie al tappo rimovibile. Disponibili in due modelli, da terra antigraffio con protezione per il pavimento (può contenere fino a 3.500 sigarette), e a parete (può contenere fino a 1.200 sigarette).

**ES** Poste cenicero de acero inoxidable cepillado o revestido en dorado, resistente a la intemperie. Fácil de limpiar y con tapa extraíble. Disponible en un modelo de pie anti-rayones para protección del piso (puede contener hasta 3.500 cigarrillos), o de pared (puede contener hasta 1.200 cigarrillos).

**PT** Poste cinzeiro com acabamento em aço inoxidável escovado ou revestido em dourado. Fácil de esvaziar com tampa removível. Disponível em um modelo de fixação em base (pode conter até 3.500 cigarros), e um modelo com fixação em parede pode conter até 1.200 cigarros).

**NL** Weerbestendig geborsteld, gecoate zwart of goud roestvrij staal. Eenvoudig te reinigen, verwijderbare dop. Verkrijgbaar in vrijstaande modellen met vloerbescherming (kan tot 3.500 sigaretten bevatten) en een model voor wandmontage (kan tot 1.200 sigaretten bevatten).



1	x	3		
1	SP-SS-SM-F2	100,5x6x6,8cm	1,3kg	
2	SP-SS-SM-F1	4x25x25cm	3,8kg	
3	SP-BL-SM-F2	100,5x6x6,8cm	1,3kg	
4	SP-BL-SM-F1	4x25x25cm	3,8kg	
5	SP-GD-SM-SET	104x25x25cm	5,1kg	

1	x	6		
6	SP-SS-WM2	41,2x6x6,9cm	0,5kg	





# IN-STORE DISPLAYS

- FR** PLV
- DE** DISPLAYS FÜR GESCHÄFTSRÄUME
- IT** ESPOSITORI
- ES** EXPOSITOR DE TIENDA
- PT** DISPLAY DE LOJA
- NL** STORE DISPLAYS

# POS-DISPLAY-5



Top banner  
POS-DISPLAY-20

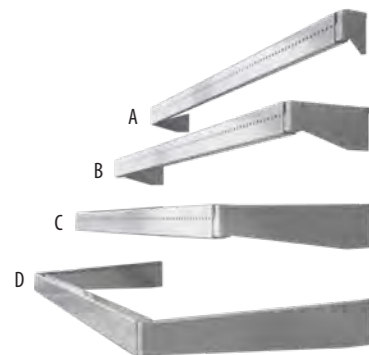

- EN** 4 loose brackets (shelves and back panel not included).
- FR** Quatre supports indépendants (étagères et support de fond non inclus).
- DE** 4 Wasserfall-Elemente ((Regal-) Rückwand & -Böden nicht inklusive).
- IT** 4 Braccia di metallo con differenti profondità da agganciare al banco (gondola e ripiani non inclusi).
- ES** 4 barras de metal con distintas profundidades para conectar al panel (góndola y estantes no incluidos).
- PT** 4 suportes de metal avulsos (prateleiras e painel traseiro não incluido).
- NL** 4 losse beugels (exclusief planken en achterwand).

**Colour:** Grey  
**Material:** Metal  
**SKU:** ± 15  
**Size:** A. 100/140x5x3cm\*  
 B. 100/140x5x16cm\*  
 C. 100/140x5x28cm\*  
 D. 100/140x5x40cm\*

\*Width adjustable from 100 to ±140cm

# POS-DISPLAY-12

(POS-DISPLAY-3 & POS-DISPLAY-4)



**POS-DISPLAY-3**  
**Type:** Hooks  
**Colour:** Grey  
**Material:** Laminated wood  
**SKU:** ± 20  
**Size:** 143x118x40cm

**POS-DISPLAY-4**  
**Type:** Shelves  
**Colour:** Grey  
**Material:** Laminated wood  
**SKU:** ± 20  
**Size:** 143x118x40cm

**POS-DISPLAY-12**  
**Type:** Hooks + Shelves  
**Colour:** Grey  
**Material:** Laminated wood  
**SKU:** ± 40  
**Size:** 143x118x80cm

# POS-DISPLAY-23

**Colour:** Birch  
**Material:** Wood  
**SKU:** ± 20  
**Size:** 175x66x59cm



EN Double sided FR Double face DE Doppelseitig IT Bifacciale  
 ES Dos lados PT Om dois lados NL Dubbelzijdig

# POS-DISPLAY-24

**Colour:** Birch  
**Material:** Wood  
**SKU:** ± 20  
**Size:** 170x120x39cm



# POS-DISPLAY-30

**Colour:** Birch  
**Material:** Wood  
**SKU:** ± 15  
**Size:** 175x79x31cm



# POS-DISPLAY-27

**Colour:** Birch  
**Material:** Wood  
**SKU:** ± 5  
**Size:** 70x55x25cm

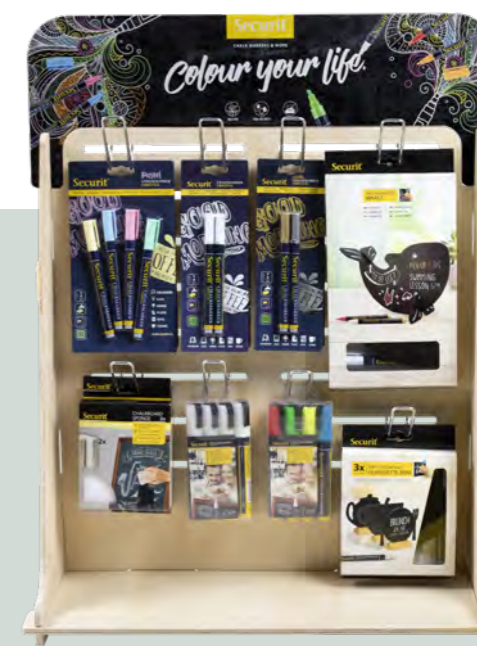

# POS-DISPLAY-8

**Colour:** Black  
**Material:** Plastic  
**SKU:** 22  
**Size:** 39x41x14cm  
**Capacity:** 10x30 SMA100  
 10x12 SMA510/SMA610  
 12x3 SMA720/SMA820



## POS-DISPLAY-18

**Colour:** Grey  
**Material:** Metal  
**SKU:** ± 30  
**Size:** 148x100x57cm



## POS-DISPLAY-17

**Colour:** Black  
**Material:** Metal & PU  
**SKU:** ± 20  
**Size:** 200x28x26cm



## POS-DISPLAY-6

**Colour:** Black  
**Material:** Laminated wood  
**SKU:** ± 20  
**Size:** 118x80x53cm



## POS-DISPLAY-25

**Colour:** Grey/Silver  
**Material:** Carton  
**SKU:** ± 20  
**Size:** 179x39x59cm



EN Double sided FR Double face DE Doppelseitig IT Bifacciale  
 ES Dos lados PT Om dois lados NL Dubbelzijdig



# INDEX

B	P	EAN	ELE-BL-ME	24	8718226491831	FBT-MEMO	27	8718226495921
BL-SMA100-V2-BL	74	8719075286227	ELE-BL-SM	24	8718226492494	FBT-MIX-3	27	8718226496690
BL-SMA100-V2-GDSL	74	8719075280027	ELE-DB-LA	25	8717624244704	FBT-NOTES	27	8719075286128
BL-SMA100-V2-WHI	74	8719075280010	ELE-DB-ME	25	8717624244698	FBT-PLATE	27	8718226495976
BL-SMA100-V4-COL	74	8718226492661	ELE-M-LA	24	8717624241321	FBT-PLATE-3	27	8718226496386
BL-SMA100-V4-PAS	74	8719075287767	ELE-M-ME	24	8717624241284	FBT-RECT-4	27	8719075285121
BL-SMA100-V4-TRO	74	8718226492678	ELE-M-SM	24	8717624241246	FBT-TEAPOT	27	8718226495983
BL-SMA100-V4-WHI	74	8718226493811	ELE-S-LA	24	8717624243653	FBT-TEAPOT-3	27	8718226496409
BL-SMA100-V7-AS	74	8718226492722	ELE-S-ME	24	8717624243660	FBTA-A4	28	8718226496959
BL-SMA100-V7-MT	74	8719075285091	ELE-S-SM	24	8717624243677	FBTA-BEER	28	8718226497024
BL-SMA100-V7-WT	74	8718226492753	ELE-TE-LA	24	8717624244100	FBTA-BURGER	28	8718226496997
BL-SMA510-BU	76	8717624242243	ELE-TE-ME	24	8717624244117	FBTA-CHAMPAIGN	28	8718226497048
BL-SMA510-GD	76	8717624245411	ELE-TE-SM	24	8718226495631	FBTA-CHEF	28	8718226497017
BL-SMA510-GR	76	8717624242250	EZL-B-165	19	8717624241888	FBTA-COCKTAIL	28	8718226497055
BL-SMA510-OR	76	8717624242267	EZL-BL-165	19	8718226491824	FBTA-CUP	28	8718226496973
BL-SMA510-PI	76	8717624242274	EZL-DB-165	19	8717624244230	FBTA-ICECREAM	28	8718226497079
BL-SMA510-RD	76	8717624242229	EZL-M-165	19	8717624241871	FBTA-MENU	28	8718226496980
BL-SMA510-SL	76	8717624245428	EZL-TE-165	19	8717624244094	FBTA-PIZZA	28	8718226497062
BL-SMA510-VT	76	8717624242281	<b>F</b>			FBTA-PLATE	28	8718226496966
BL-SMA510-WT	76	8717624242212	FB-APPLE	61	8719075286067	FBTA-SANDWICH	28	8718226497000
BL-SMA510-YE	76	8717624242236	FB-BALLOON	61	8719075286098	FBTA-WINE	28	8718226497031
BL-SMA610-WT	82	8719075281383	FB-BOTTLE	61	8718226493309	<b>J</b>		
BL-SMA720-BU	78	8717624242342	FB-BUBBLE	59	8718226499714	JUN-M-A4	33, 75	8717624241369
BL-SMA720-GR	78	8717624242359	FB-BUTTERFLY	61	8718226493873	<b>L</b>		
BL-SMA720-OR	78	8717624242366	FB-CACTUS	61	8719075286517	LES-BL-100	66	8719075283127
BL-SMA720-PI	78	8717624242373	FB-CLOCK	59	8719075283745	LES-TE-100	66	8719075283110
BL-SMA720-RD	78	8717624242328	FB-CLOUD	61	8718226493408	LP-BL-1	20, 155, 157,	8719075283905
BL-SMA720-VT	78	8717624242380	FB-CUP	59	8718226493866	LP-BL-2	20, 159	8719075283936
BL-SMA720-WT	78	8717624242311	FB-FLAG	59	8719075283691	LP-BL-TA	36	
BL-SMA720-YE	78	8717624242335	FB-FLOWER	61	8718226493392	LS-BAR	137	8718226491596
BL-SMAMIX-V5-WT	74	8718226496263	FB-GLASS	61	8718226493880	LS-OPEN	137	8718226491602
			FB-HEART	59	8718226493385	LS-PIZZA	137	8718226491572
			FB-LEAF	61	8719075285831	LW-GY-58	57	8719075280850
			FB-MOKA	59	8719075283707	LW-GY-78	57	8719075280874
			FB-OVAL	61	8718226493415	<b>M</b>		
			FB-PINEAPPLE	61	8719075286524	MC-BOX-BRA4-BL	109	8719075284025
			FB-PLAN	59	8719075283738	MC-BOX-BRA4-WR	109	8719075284032
			FB-SM4	61	8719075283714	MC-BOX-CRA4-BL	93	8717624245213
			FB-SQUARE	61	8718226493354	MC-BOX-CRA4-BR	93	8717624245237
			FB-WIFI	61	8719075283721	MC-BOX-CRA4-WR	93	8717624245220
			FB-XXL	63	8719075285237	MC-BOX-DRA4-CORK	101	8717624249198
			FBS-ARROW	21	8718226499264	MC-BOX-DRA4-PAISLEY	101	8717624249211
			FBS-RECTANGLE	21	8718226499271	MC-BOX-DRWC-CORK	101	8717624249334
			FBT-CARRY	27	8719075283875	MC-BOX-TRA4-BL	95	8717624245169
			FBT-CUP	27	8718226495938			
			FBT-CUP-3	27	8718226496393			
			FBT-HOUSE	27	8718226495952			

MC-BOX-TRA4-BU	95	8717624245206	MC-LDSP-CP	121	8718226496164	MC-TRA5-BU	95	8717624240140
MC-BOX-TRA4-GR	95	8717624245190	MC-LDSP-SL	121	8718226496195	MC-TRA5-GR	95	8717624240188
MC-BOX-TRA4-LB	95	8717624245183	MC-LIA4-IJ	120	8718226495815	MC-TRA5-LB	95	8717624240201
MC-BOX-TRA4-WR	95	8717624245176	MC-LIA4-LJ	120	8718226495785	MC-TRA5-WR	95	8717624240164
MC-BOX-WRA4-BL	105	8717624245596	MC-LRA4-EGBL	90	8719075284070	MC-TRBC-WT	101	8718226493088
MC-BOX-WRA4-BR	105	8717624245633	MC-LRA4-ROBL	90	8719075284049	MC-TRBP-BL	95, 123	8717624240782
MC-BOX-WRA4-WR	105	8717624245619	MC-LRA4-RORD	90	8719075284056	MC-TRWC-BL	95	8717624240805
MC-BP-BSS	122	8719075286425	MC-LRA4-RUBR	89, 90	8719075288146	MC-WALA4-CB	112	8719075285275
MC-BPBLOCK-TE	122	8719075285459	MC-LRA4-RWBL	90	8719075284063	MC-WALA4-CH	111	8719075285206
MC-BPBOX-AN	122	8719075285428	MC-LRA4-RWBR	90	8719075284087	MC-WALA4-PU	110	8719075285305
MC-BPBOX-TR	95, 124	8719075285367	MC-LRA4-RWWT	90	8719075284094	MC-WALA4-RB	111	8719075285336
MC-BRA4-BL	109	8717624249051	MC-LRA5-RUBR	89, 90	8719075288085	MC-WALA4-SC2	113	8719075288351
MC-BRA4-WR	109	8717624249082	MC-LRA5-RWBL	90	8719075287743	MC-WALA5-SC2	113	8719075288382
MC-BRA5-BL	109	8717624248993	MC-LRPM-RUBR	89, 90	8719075288115	MC-WALBP-BL	112, 122	8719075286432
MC-BRA5-WR	109	8717624249020	MC-LRPM-RWBL	90	8719075284445	MC-WIA4-BL	105	8717624240720
MC-BRBP-BL	109, 123	8718226493668	MC-MGA4-BL	119	8719075280881	MC-WIA4-BR	105	8717624240768
MC-BRWC-BL	109	8718226492180	MC-MGA4-BR	119	8719075281482	MC-WIA4-BU	105	8717624240737
MC-CBA4-BR	117	8719075280171	MC-NTA4-BI	99	8719075288177	MC-WIA4-WR	105	8717624240744
MC-CBA4-MT	116	8719075287798	MC-NTA4-BL	99	8719075288207	MC-WIA5-BL	105	8717624240324
MC-CBA4-VT	115	8719075288511	MC-NTA4-BR	99	8719075288238	MC-WIA5-BR	105	8717624240362
MC-CBA5-VT	115	8719075288542	MC-NTA5-BI	99	8719075288269	MC-WIA5-BU	105	8717624240331
MC-CBBP-BR	117, 123	8719075281017	MC-NTA5-BL	99	8719075288290	MC-WIA5-WR	105	8717624240348
MC-CR45-BL	93	8718226490513	MC-NTA5-BR	99	8719075288320	MC-WRA4-BL	105	8717624240409
MC-CR45-WR	93	8718226490520	MC-RCA4-BL	97	8718226497505	MC-WRA4-BR	105	8717624240485
MC-CRA4-BL	93	8717624240621	MC-RCA4-BL-FK	97	8718226498557	MC-WRA4-BU	105	8717624240423
MC-CRA4-BR	93	8717624240683	MC-RCA4-BU	97	8718226497529	MC-WRA4-WR	105	8717624240447
MC-CRA4-WR	93	8717624240669	MC-RCA4-BU-FK	97	8718226498564	MC-WRA5-BL	105	8717624240003
MC-CRA5-BL	93	8717624240225	MC-RCA4-GR	97	8718226497536	MC-WRA5-BR	105	8717624240089
MC-CRA5-BR	93	8717624241413	MC-RCA4-GR-FK	97	8718226498601	MC-WRA5-BU	105	8717624240027
MC-CRA5-WR	93	8717624240263	MC-RCA4-OR	97	8718226497543	MC-WRA5-WR	105	8717624240041
MC-CRBP-BL	93, 123	8717624240829	MC-RCA4-OR-FK	97	8718226498618	MC3-CYA4-BR1	118	8717624244810
MC-CRWC-BL	93	8717624240843	MC-RCA4-RD	97	8718226497512	MC3-CYA4-BR2	118	8717624244827
MC-DBBP-BL	95, 124	8719075283219	MC-RCA4-RD-FK	97	8718226498588	MC3-CYA4-BR3	118	8717624244834
MC-DBBP-GY	90, 124	8719075283189	MC-RCA4-VT	97	8718226497550	MCS-115-TE	157	8719075283172
MC-DR45-CROC	101	8718226493040	MC-RCA4-VT-FK	97	8718226498595	MCS-2A4-PA	153	8717624240096
MC-DRA4-CORK	101	8717624247019	MC-RCA4-WT	97	8718226498021	MCS-3A4-CS	147	8717624248597
MC-DRA4-PAISLEY	101	8717624246869	MC-RCA4-WT-FK	97	8718226498571	MCS-4A4-BL-SET	143	8718226497987
MC-DRA4-VELVET	101	8718226493750	MC-RCA5-BL	97	8719075286036	MCS-4A4-LSS	145	8718226492555
MC-DRA4-WOOD	101	8718226495709	MC-RCWC-BL	97	8718226497864	MCS-4A4-OAK	155	8719075281574
MC-DRWC-CORK	101	8717624246883	MC-TI45	103	8717624249747	MCS-4A4-WAL	155	8719075281581
MC-DRWC-VELVET	101	8718226493781	MC-TIA4	103	8717624240393	MCS-4A4-WLDB	149	8719075281598
MC-ESA4-BL	107	8719075288412	MC-TIA5	103	8717624240386	MCS-4A4-WLR	151	8719075281628
MC-ESA5-BL	107	8719075288443	MC-TR45-BL	95	8718226490483	MCS-4A4-WLR-SET	151	8719075281635
MC-LD-MC10	36, 120	8718226496294	MC-TR45-LB	95	8718226490490	MCS-4A4-WLSS	149	8719075281611
MC-LD45-BL	121	8718226495136	MC-TR45-WR	95	8718226490506	MCS-4A4-WLTE	149	8719075281604
MC-LD45-CP	121	8718226496157	MC-TRA4-BL	95	8717624240522	MCS-6A4-CS	147	8717624248603
MC-LD45-SL	121	8718226496188	MC-TRA4-BU	95	8717624240546	MCS-6A4-LSS	145	8718226492562
MC-LDA4-BL	121	8718226495129	MC-TRA4-GR	95	8717624240584	MCS-8A4-BL	141	8719075287316
MC-LDA4-CP	121	8718226496140	MC-TRA4-LB	95	8717624240607	MCS-A4-OAK	155	8719075281550
MC-LDA4-SL	121	8718226496171	MC-TRA4-WR	95	8717624240560	MCS-A4-WAL	155	8719075281567
MC-LDSP-BL	121	8718226496096	MC-TRA5-BL	95	8717624240126	MCS-BA-110-BL1	141	8719075287323

MCS-BA-120-G1	145	8718226492579	PFT-MAG-A7	132	8719075287163
MCS-BA-125-SET	145, 149, 153, 155, 159	8719075281543	PFT-MAG-A8	132	8719075287194
MCS-BA-135-SETB	147	8719075285596	PFT-PWB	136	8717624249570
MCS-BA-85-SET	155	8719075281536	PFT-TE-LA	133	8717624248047
MCS-BA-95-SETB	147	8719075285602	PFT-TE-ME	133	8717624248030
MCS-BA-BL2	141	8719075286487	PFT-TE-SM	133	8718226497994
MCS-BA-G2	145	8718226492586	PFW-27-36-BL	135	8719075280898
MCS-BATT	20, 141, 143, 145, 147, 149, 151, 155, 157, 159	8717624249877	PFW-A3-BL	134	8717624248344
MCS-WH-2	143, 145, 147, 149, 151, 153, 155, 157, 159	8719075284018	PFW-A3-GY	134	8717624248351
MNI-B-KR	32	8717624241222	PFW-A3-YE	134	8717624248375
MNI-B-KR-1	32	8718226495440	PFW-A4-BL	134	8717624248382
MNI-BL-KR	32	8718226495006	PFW-A4-GY	134	8717624248399
MNI-BL-KR-1	32	8718226495426	PFW-A4-YE	134	8717624248412
MNI-M-KR	32	8717624241208	PNT-BL-LA	67	8719075281055
MNI-M-KR-1	32	8717624240874	PNT-BL-SM	67	8719075281062
P			PNT-GY-SM	67	8719075283059
PFT-ACL-A4	130	8719075280775	R		
PFT-ACL-A5	130	8719075280782	RS-200-BL	171	8719075282656
PFT-ACL-A6	130	8719075280799	RS-200-RD	171	8719075282632
PFT-ACL-A8	131	8719075282182	RS-CL-CH-B1	163	8717624245336
PFT-ACM-A4	131	8719075285664	RS-CL-CH-B2	163	8717624245329
PFT-ACM-A5	131	8719075285695	RS-CL-CH-SET	163	8717624242083
PFT-ACM-A6	131	8719075285725	RS-CL-GO-A1	163	8717624245312
PFT-ACV-A4	130	8719075280829	RS-CL-GO-A2	163	8717624245305
PFT-ACV-A5	130	8719075280805	RS-CL-GO-SET	163	8717624242076
PFT-ACV-A6	130	8719075280812	RS-CLRP-CHBL	163, 167	8717624242830
PFT-ACV-A7	130	8719075282212	RS-CLRP-CHBR	163, 167	8717624242113
PFT-ACY-A5	130	8719075280836	RS-CLRP-CHBU	163, 167	8717624242090
PFT-ACY-A6	130	8719075280843	RS-CLRP-CHRD	163, 167	8717624242137
PFT-BL-LA	133	8718226494726	RS-CLRP-CHWT	163, 167	8718226496416
PFT-BL-ME	133	8718226494719	RS-CLRP-GOBL	163	8717624242847
PFT-BL-SM	133	8718226494702	RS-CLRP-GOBR	163	8717624242120
PFT-BR0-4A4	129	8720663160126	RS-CLRP-GOBU	163	8717624242106
PFT-BR0-4A5	129	8720663160096	RS-CLRP-GORD	163	8717624242144
PFT-BR0-4TA4	129	8720663160157	RS-CLRP-GOWT	163	8718226496430
PFT-BR0-A4	129	8720663160065	RS-CLWH-CH	163, 167	8717624242168
PFT-BR0-A5	129	8720663160034	RS-CLWH-GO	163	8717624242151
PFT-BR0-BC	129	8720663160218	RS-LW-CH	167	8719075281048
PFT-BR0-HHA4	128	8720663160249	RS-RT-BL-C8	170	8718226497482
PFT-BR0-HVA4	128	8720663160270	RS-RT-BL-C9	170	8718226497499
PFT-BR0-TA4	129	8720663160003	RS-RT-LW-BL	165	8719075288504
PFT-BR0-WA4	129	8720663160188	RS-RT-LW-CH	166	8719075282489
PFT-MAG-A4	132	8719075287071	RS-RT-RVS-BL-C4	169	8718226492098
PFT-MAG-A5	132	8719075287101	RS-RT-RVS-BL-SET	169	8718226496362
PFT-MAG-A6	132	8719075287132	RS-RT-RVS-BU-C5	169	8718226492371
			RS-RT-RVS-C3	169	8717624245343
			RS-RT-RVS-GY-C2	169	8717624245367
			RS-RT-RVS-GY-SET	169	8717624242182
			RS-RT-RVS-RD-C1	169	8717624245350
			RS-RT-RVS-RD-SET	169	8717624242175
			RS-RTWM-RVS-GY	169	8717624242205
			RS-RTWM-RVS-RD	169	8717624242199
			RS-SIGN-A4-BL	165, 170	8719075288610
			RS-SIGN-A4-PC	163	8718226492302
			RS-SIGN-A4-PG	163	8718226492357
			RS-SIGN-A4-PS	166, 169	8718226492319
			RST-DB-40	43	8718226499097
			RST-DB-60	43	8718226499103
			S		
			SB-WIND	20	8717624245268
			SBD-B-85	12	8717624241185
			SBD-BL-85	14	8718226491756
			SBD-DB-85	12	8717624244261
			SBD-M-85	12	8717624241178
			SBD-N-85	17	8719075287712
			SBD-NG-85	17	8719075287736
			SBD-TE-85	12	8717624244322
			SBDT-BL-80	15	8719075289914
			SBDW-TE-85	14	8718226495686
			SBM-BL-115	18	8717624242946
			SBM-FEET	18	8717624242939
			SBM-SS-115	18	8717624242922
			SBM-WT-115	18	8717624242908
			SBS-B-135	12	8717624241147
			SBS-B-MNI	34	8719075281826
			SBS-BL-120	14	8718226492975
			SBS-DB-120	12	8717624244278
			SBS-M-135	12, 83	8717624241130
			SBS-N-135	16, 79	8717624245251
			SBS-NG-135	16	8719075287729
			SBS-TE-120	12	8717624245138
			SBST-BL-120	15	8719075289907
			SBSW-M-120	14	8718226498984
			SBSW-TE-120	14	8718226495693
			SDT-B-120	13	8717624241161
			SDT-M-120	13	8717624241154
			SECCLEAN-GR	85	8717624241956
			SECCLEAN-KL	85	8717624241970
			SECSTN-5	84	8717624241932
			SI-SS-SET	135	8719075283394
			SMA100-BL	74	8719075283530
			SMA100-BU	74	8717624249945
			SMA100-GD	74	8719075280133
			SMA100-GR	74	8717624249938
			SMA100-OR	74	8717624249907
			SMA100-PI	74	8717624249921
			SMA100-RD	74	8717624249914
			SMA100-SL	74	8719075280157
			SMA100-VT	74	8717624249952
			SMA100-WT	74	8717624249884
			SMA100-YE	74	8717624249891
			SMA510-BL	76	8718226494283
			SMA510-BU	76	8717624245800
			SMA510-GD	76	8717624246098
			SMA510-GR	76	8717624245831
			SMA510-OR	76	8717624245862
			SMA510-PI	76	8717624245893
			SMA510-RD	76	8717624245923
			SMA510-SL	76	8717624246067
			SMA510-V4	76	8718226491169
			SMA510-V4-WT	76	8718226491183
			SMA510-V8	76	8717624242304
			SMA510-V8-ET	76	8718226499592
			SMA510-V8-WT	76	8717624244285
			SMA510-VT	76	8717624245978
			SMA510-WT	76	8717624246005
			SMA510-YE	76	8717624246036
			SMA610-BL	82	8719075281178
			SMA610-BU	82	8719075281185
			SMA610-GR	82	8719075281192
			SMA610-RD	82	8719075281208
			SMA610-V4	82	8719075281086
			SMA610-V4-BW	82	8719075281079
			SMA610-V4-WT	82	8719075281444
			SMA610-WT	82	8719075281215
			SMA610-YE	82	8719075281222
			SMA720-BU	78	8717624246159
			SMA720-GR	78	8717624246180
			SMA720-OR	78	8717624246210
			SMA720-PI	78	8717624246241
			SMA720-RD	78	8717624246272
			SMA720-V4	78	8718226491206
			SMA720-V4-WT	78	8718226491220
			SMA720-V8	78	8717624242403
			SMA720-V8-ET	78	8718226499691
			SMA720-V8-WT	78	8717624244292
			SMA720-VT	78	8717624246326
			SMA720-WT	78	8717624246357
			SMA720-YE	78	8717624246388
			SMA820-BL	82	8719075281239
			SMA820-BU	82	8719075281246
			SMA820-GR	82	8719075281253
			SMA820-RD	82	8719075281260
			SMA820-V2-WT	82	8719075281406
			SMA820-V4	82	8719075281109
			SMA820-V4-BW	82	8719075281093
			SMA820-V4-WT	82	8719075281390
			SMA820-WT	82	8719075281277
			SMA820-YE	82	8719075281284
			SP-BL-SM-F1	172	8718226494320
			SP-BL-SM-F2	172	8718226494344
			SP-GD-SM-SET	172	8719075287781
			SP-SS-SM-F1	172	8717624247514
			SP-SS-SM-F2	172	8717624247538
			SP-SS-WM2	172	8719075283516
			SPONGE-2	84	8718226498540
			STN-SS-CO	45	8719075283332
			T		
			TAG-A4-WT	38	8718226491428
			TAG-A5-WT	38	8718226491435
			TAG-A6-BL	38	8719075283608
			TAG-A6-WT	38	8718226491442
			TAG-A7-BL	38	8719075283615
			TAG-A7-WT	38	8718226491459
			TAG-A8-BL	38	8719075283622
			TAG-A8-WT	38	8718226491466
			TAG-B0-WT	40	8719075283547
			TAG-BOTTLE	40	8719075285152
			TAG-BUBBLE-5	30	8718226498991
			TAG-BUTTERFLY-5	30	8718226499004
			TAG-FLOWER-5	30	8718226499011
			TAG-HLD-AC	39	8719075283264
			TAG-HLD-BL	39	8718226499837
			TAG-HLD-CP	39	8719075283257
			TAG-HLD-TE	39	8719075283240
			TAG-HLD-TR	39	8718226499820
			TAG-RECTANGLE-5	30	8718226499318
			TAG-SBS-WT	35	8719075283554
			TBA-BL-A5	31	8718226499745
			TBA-BL-A6	31	8718226499752
			TBA-BL-A7	31	8718226499769
			TBA-BL-A8	31	8718226499776
			TN-1-10-WT	44	8718226498113
			TN-11-20-WT	44	8718226498120
			TN-21-30-WT	44	8718226498137
			TN-31-40-WT	44	8718226498144
			TN-41-50-WT	44	8718226498151
			TN-51-60-WT	44	8718226498168
			TN-RES-DE-WT	44	8718226498311
			TN-RES-EN-WT	44	8718226498304
			TN-RES-ES-WT	44	8718226498502
			TN-RES-FR-WT	44	8718226498328
			TN-RES-IT-WT	44	8718226498335
			TN-RES-NL-WT	44	8718226498298
			TT-DB-LA	25, 77	8717624244575
			TT-DB-XL	25	8717624244582
			W		
			WB-WR-1	41	8717624240010
			WB-WR-3	41	8717624240034
			WBC-G-105	56	8717624241505
			WBC-G-85	56	8717624241499
			WBL-DB-100	55	8717624244315
			WBL-DB-120	55	8717624244131
			WBL-DB-150	55	8717624244148
			WBL-TE-100	55	8717624244308
			WBL-TE-120	55	8717624244018
			WBL-TE-150	55	8717624244025
</					